Practice Note 29

Dairy Housing

Engineering Practice

ISSN 1176-0907
Version 1, July 2015



DairyNZ

An Investment by New Zealand Dairy Farmers

Preface

The purpose of *Practice Note 29: Dairy Housing* is to offer good practice guidance in the development, design and construction of building structures for housing dairy cows on New Zealand farms. It is intended to be a reference source for engineering practitioners, contractors, farmers, product suppliers, regional council and local authority staff, and others involved in the dairy industry.

For this Practice Note a housed cow is one that spends a significant proportion of its day or year in an off-paddock facility, but excludes covered stand-off and feed pads.

This Practice Note has an intentional engineering focus. DairyNZ has produced a parallel document targeted at dairy farmers:

Dairy cow housing - A good practice guide for dairy housing in New Zealand

www.dairynz.co.nz/media/2240383/dairy-cow-housing-guide.pdf

Topics include:

1. Design aspects to consider when looking at housing system options
2. Factors affecting housed cow comfort
3. Good practice management principles for housed cows
4. Options for future-proofing your barn
5. Code of Welfare minimum standards.

Those involved in the design of dairy housing structures should refer to this informative document.

Practice Note 29 is complementary to and follows on from the previously released:

- *Practice Note 21: Farm Dairy Effluent Pond Design and Construction*
- *Practice Note 27: Dairy Farm Infrastructure*

Practice Note Development

The Institution of Professional Engineers New Zealand (IPENZ), with support from principal sponsors DairyNZ, has brought together a group of professionals from civil, structural, agricultural and environmental engineering backgrounds to develop this Practice Note.

The IPENZ Engineering Practice Advisory Committee has given the Practice Note lead author the task of preparing a document to be adopted by the dairy engineering industry that reflects a national perspective. The Practice Note has been prepared in accordance with standard IPENZ Practice Note procedures. This includes reporting on progress to the Engineering Advisory Committee, peer review and general Membership review. This review and reporting process ensures the delivery of a robust, good-practice technical document.

While the lead author and other contributors have made every effort to present a carefully considered Practice Note based on professional practice, as well as consultation with the wider industry, they accept that what constitutes good practice may alter over time following changes in knowledge, technology and legislation. They also acknowledge that different versions and interpretations of relevant legislation and regulations are possible and that each practitioner needs to confirm with the relevant authorities to ensure their specific requirements are being met.

The development of this practice note was funded by DairyNZ and the Ministry for Primary Industries through the "Transforming the dairy value chain primary growth partnership".

Glossary

| | |
|--------------|--|
| AEE | Assessment of Environmental Effects |
| BA | Building Act |
| BC | Building Code |
| BCA | Building Consent Authority |
| BOD | Biochemical Oxygen Demand |
| CCANZ | Cement and Concrete Association of New Zealand |
| CCC | Code Compliance Certificate |
| CoC | Certificate of Compliance |
| CM | Construction Monitoring |
| CPEng | Chartered Professional Engineer |
| DESC | Dairy Effluent Storage Calculator |
| DM | Dry Matter |
| FDE | Farm Dairy Effluent |
| GPG | Good Practice Guide <i>Dairy cow housing – A good practice guide for dairy housing in New Zealand</i> |
| HERA | Heavy Engineering Research Association |
| HSE | Health and Safety in Employment Act |
| IPENZ | Institution of Professional Engineers New Zealand |
| LBP | Licensed Building Practitioner |
| LIM | Land Information Memorandum |
| MBIE | Ministry of Business, Innovation and Employment |
| MfE | Ministry for the Environment |
| MPa | Megapascal |
| MPI | Ministry of Primary Industries |

| | |
|--------------|--|
| NIWA | National Institute of Water and Atmospheric Research |
| NZGS | New Zealand Geotechnical Society |
| NZHPT | New Zealand Historic Places Trust |
| NZS | New Zealand Standard |
| PC | Polycarbonate |
| PE | Polyethylene |
| PKE | Palm Kernel Expeller |
| PIM | Project Information Memorandum |
| PIR | Passive Infrared |
| PM | Project Manager |
| PN | Practice Note |
| PS | Producer Statement |
| PVC | Polyvinyl Chloride |
| Ra | Colour Rendering Index |
| RBW | Restricted Building Work |
| RC | Regional Council |
| RMA | Resource Management Act |
| RPZ | Reduced Pressure Zone |
| SCM | Supplementary Cementitious Materials |
| SED | Specific Engineering Design |
| SLS | Serviceability Limit State |
| TS | Total Solids |
| ULS | Ultimate Limit State |
| UV | Ultra Violet |

Contents

| | | | |
|--------------------------------------|-----------|---|-----------|
| Chapter 1: Project Management | 6 | Chapter 3: Services | 53 |
| 1. Introduction | 7 | 1. Introduction | 54 |
| 1.1 Project delivery options | 8 | 2. Water | 54 |
| 1.2 Contracts | 8 | 2.1 Water distribution | 55 |
| 1.3 Role of the project manager | 10 | 2.2 Water storage | 55 |
| 2. Legislative Requirements | 11 | 2.3 Pipework | 56 |
| 3. Estimates | 13 | 2.4 Water for cleaning | 57 |
| 3.1 Value management | 13 | 2.5 Water for humidity/temperature control | 57 |
| 3.2 Certification | 13 | 3. Electrical | 57 |
| 4. Project Phases | 14 | 3.1 Introduction | 57 |
| 4.1 Investigating the options | 14 | 3.2 Electrical general comments | 58 |
| 4.2 Developing the design | 14 | 4. Lighting | 59 |
| 5. Construction Phase | 18 | 4.1 Properties of light | 59 |
| 5.1 Introduction | 18 | 4.2 Provision of light | 61 |
| 5.2 Preconstruction | 18 | 4.3 Types of lighting | 62 |
| 5.3 Construction | 23 | 4.4 Lighting control | 64 |
| 5.4 Post construction | 24 | 4.5 Lighting system design | 64 |
| Chapter 2: Floor Plan | 27 | Chapter 4: Ventilation | 66 |
| 1. Flooring | 28 | 1. Introduction | 67 |
| 1.1 Introduction | 28 | 2. Environmental Parameters and Cow Comfort | 68 |
| 2. Dairy Housing Options | 31 | 2.1 Temperature and humidity index | 69 |
| 2.1 Feed and stand-off pads | 31 | 3. Air Environmental Control Principles | 70 |
| 2.2 Loose housed systems | 32 | 3.1 Basic principles | 70 |
| 2.3 Freestall | 36 | 3.2 Psychrometric principles of air | 70 |
| 3. Concrete Floors | 45 | 3.3 Principles of heat and shade control | 72 |
| 3.1 Concrete surfacing | 45 | 4. Ventilation Systems | 75 |
| 3.2 Grooved concrete | 45 | 4.1 Ventilation key parameters | 75 |
| 3.3 Slatted floors | 46 | 4.2 Natural versus mechanical ventilation | 75 |
| 3.4 Automatic scrapers | 47 | 5. Building Design | 77 |
| 4. Design Considerations | 48 | 5.1 Siting and orientation | 77 |
| 4.1 Sloped floors | 48 | 5.2 Building openings | 78 |
| 4.2 Entrance areas | 48 | 5.3 Insulated buildings | 79 |
| 4.3 Floor cleaning | 49 | 6. Active Ventilation | 80 |
| 5. Layout | 50 | 6.1 Extraction and pressurising fans | 80 |
| 5.1 Accessibility | 50 | 6.2 Ducting | 81 |
| 5.2 Supporting facilities | 50 | | |
| 5.3 Turning circles | 51 | | |

Contents

| | | | |
|---|------------|--|------------|
| 7. Cooling | 82 | 3. Earthquake | 118 |
| 7.1 Cooling fans | 82 | 3.1 Earthquake zones | 118 |
| 7.2 Supplementary cooling | 83 | 3.2 Other seismic related risks | 119 |
| Chapter 5: Effluent Systems | 86 | 4. Snow | 120 |
| 1. Effluent Characteristics | 87 | 5. Corrosion | 122 |
| 1.1 Total solids | 88 | 5.1 Corrosion zones | 122 |
| 1.2 Effluent system approaches | 88 | 6. Geotechnical | 123 |
| 2. Dry systems | 90 | 6.1 Site conditions and ground stability | 123 |
| 2.1 Slatted floor systems with underfloor bunker | 90 | 6.2 Preliminary survey | 123 |
| 2.2 Composting floors | 91 | 6.3 Bearing pressure | 123 |
| 2.3 Tractor scraping | 91 | 6.4 Soil types of insufficient bearing pressure | 124 |
| 2.4 Subsurface design | 92 | 6.5 Fill | 124 |
| 3. Slurry Systems | 93 | 6.6 Water table | 124 |
| 3.1 Mechanical passageway scrapers | 93 | 6.7 Test pits | 125 |
| 3.2 Gratings | 94 | 6.8 Landslides, slumps and erosion | 126 |
| 4. Wet Systems | 95 | 6.9 Gathering information | 126 |
| 4.1 Flood wash | 95 | Chapter 7: Building Structure | 128 |
| 4.2 Recycled FDE | 98 | 1. Structural Design Principles | 129 |
| 4.3 Manual wash-down | 98 | 1.1 Design standards - loadings | 129 |
| 5. Solids Separation | 100 | 1.2 Limit states | 130 |
| 5.1 Comparison of solid separation systems | 100 | 1.3 Importance Levels (IL) | 130 |
| 5.2 Sludge calculation | 104 | 1.4 Specified Intended Life | 130 |
| 5.3 Pumps | 105 | 1.5 Design working life | 130 |
| 6. Effluent Storage | 106 | 2. Structural Form | 131 |
| 7. Health and Safety | 107 | 2.1 Beams | 131 |
| Chapter 6: Site Selection | 111 | 2.2 Columns | 132 |
| 1. Introduction | 112 | 2.3 Post and beam | 132 |
| 2. Wind | 113 | 2.4 Cantilever construction | 132 |
| 2.1 Gathering local wind condition information | 114 | 2.5 Bracing | 132 |
| 2.2 Wind zone classification for design | 114 | 3. Building Frame Considerations | 133 |
| 2.3 Specific engineering design | 115 | 3.1 Open side flexibility | 133 |
| 2.4 Wind effects on pitched roofs | 116 | 3.2 Buildability | 133 |
| 2.5 Roofing | 117 | 3.3 Modifying existing building | 133 |
| | | 3.4 Extending existing buildings | 133 |
| | | 4. Timber or Steel Structure? | 135 |
| | | 4.1 Durability | 136 |
| | | 4.2 Maintenance | 137 |

Contents

| | | | |
|--|------------|--|------------|
| 4.3 Cost | 137 | Chapter 8: Consents | 167 |
| 4.4 Bird perch and nesting | 137 | 1. Introduction | 168 |
| 4.5 Foundations | 137 | 2. Resource Consents | 168 |
| 4.6 Organic certification | 137 | 2.1 Resource Management Act 1991 | 168 |
| 5. Fixings and Connections | 138 | 2.2 What is a resource consent? | 168 |
| 5.1 Nails | 138 | 2.3 District and Regional Plans | 169 |
| 5.2 Screws | 138 | 2.4 Classification of activity | 173 |
| 5.3 Bolts | 139 | 2.5 Preparing the resource consent application | 176 |
| 5.4 Connector plates | 139 | 2.6 Preparing an assessment of environmental effects | 178 |
| 5.5 Galvanised fasteners | 140 | 2.7 Consultation requirements | 180 |
| 5.6 Structural connections | 140 | 2.8 Identifying effects | 180 |
| 5.7 Column foundation detail | 141 | 2.9 What is remedying, avoiding or mitigating effects? | 181 |
| 5.8 Resilient building design | 142 | 3. Building Consents | 182 |
| 6. Timber | 143 | 3.1 The Building Act 2004 | 182 |
| 6.1 Timber treatment | 143 | 3.2 What is a building consent? | 182 |
| 7. Steel | 145 | 3.3 Building consent application | 184 |
| 7.1 Introduction | 145 | 3.4 Building consent amendments | 187 |
| 7.2 Steel selection | 146 | 3.5 Building consent compliance inspections | 188 |
| 7.3 Steel corrosion | 148 | | |
| 7.4 Protective coatings | 150 | | |
| 7.5 Inspection | 152 | | |
| 7.6 Maintenance | 152 | | |
| 7.7 Accessibility | 153 | | |
| 8. Plastic Roof Covering Options | 154 | | |
| 8.1 Rigid Polyvinyl chloride (PVC) and Polycarbonate (PC) sheeting | 154 | | |
| 8.2 Flexible plastic roof covering options | 155 | | |
| 8.3 Shade options | 156 | | |
| 8.4 Other plastic film considerations | 157 | | |
| 9. Concrete | 158 | | |
| 9.1 Concrete - key design and construction principles | 158 | | |
| 9.2 Guidance documents - concrete | 158 | | |
| 9.3 Loading | 160 | | |
| 9.4 Concrete properties | 160 | | |
| Appendix: Specifying Concrete Floors for Dairy Farms | 165 | | |
| 1. Concrete specification | 165 | | |

Chapter 1

Project Management

1. Introduction

Effective project management is critical to meeting objectives during planning, installation and operation of any new dairy housing operation. Farmers are often time poor so engaging one or more specialists to manage the various phases of work is beneficial.

The processes of planning, designing, organising, monitoring and managing are essential to delivering a farm structure that meets a farmer's expectations and goals. The challenge of project management is to achieve all of the project goals and objectives while allowing for the constraints. The primary constraints are almost always one or more of the competing challenges of scope, time, quality and cost. A secondary and more ambitious constraint is to optimise and integrate inputs to meet agreed objectives.

As illustrated in Figure 1.1 projects can generally be broken into four phases. Progress from one work phase to the next provides "hold points". These allow a farm owner, in consultation with their specialist advisors, to evaluate the project thus far and make a "go/no go" decision as to whether to proceed.

Figure 1.1: Work Phases

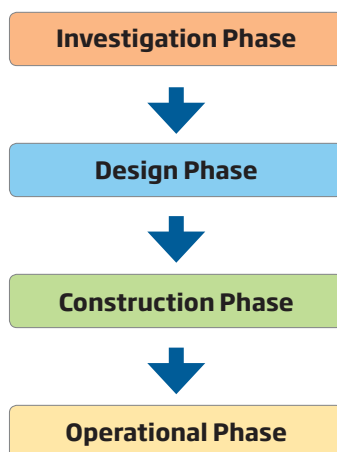

External influences unrelated to physical construction can have a dynamic effect on whether objectives can be met. Changes that may impact the economic and environmental viability of the project include:

- Dairy payout from milk supply company
- Cost of imported supplementary feed
- Regulatory change
- New technology
- Water quality and quantity issues
- Materials cost escalation.

1.1 Project delivery options

One or more of the following delivery options are available to a farmer for the design and construction phases:

- Self-managed design and construction using farm staff, for simple structures
- Engagement of a specialist project manager (PM) who contracts in all the required inputs, supervises contractor work and directly reports to the farm owner
- Design and build contract accepted with a supplier who takes on all the design and construction activities, and provides on-site management and coordination. Suppliers arrange their own specialists as needed.
- Design phase contracted out to professionals, such as a structural engineer or quantity surveyor. Construction phase is managed by a lead contractor who undertakes the work.
- A consultant engineer or architect engaged to undertake the design and manage construction contractor(s) on behalf of the landowner.

The option adopted will be a response to specific project factors such as project budget, size, complexity, latest completion date, previous working relationships and project risk profile.

Whatever option is adopted, a single person needs to take on the PM role for the whole project, or parts of it depending on its size and complexity. This is the person that the farm owner can refer questions to as they arise.

Some farmers may choose to project manage themselves but before they decide to undertake this task they should be familiar with all the likely requirements covered in this chapter.

1.2 Contracts

In all cases the relationships between the various parties and the farm owner need to be clearly and formally recorded in a contract that provides legal protection to the parties whether they are a consultant, contractor or supplier. The contract needs to clearly set out:

- Scope of the intended work
- When key aspects of the work, also known as milestones, are to be completed by
- Roles and responsibilities of the affected parties
- Standards, codes and regulations that are to be met
- How, when and on what basis parties are paid
- What happens in the event of a dispute
- Obligations of the parties on and after completion.

The most appropriate form for consultant engagement contract is the IPENZ “Short Form Agreement for Consultant Engagement” available on the IPENZ website. For contractors it may be NZS 3910 Conditions of contract for building and civil engineering construction or one of the other New Zealand standard conditions of contract available.

Many contractors and suppliers will have their own contract forms and farm owners should check that they cover the previous key points and those in Table 1.1.

Table 1.1: What Should a Contract Include?

Scope of the Project

Ensure the scope covers what is expected including critical details, such as type of structure, size, location, standards, regulations.

Programme

When will the work start and finish. Have allowances been made for delays such as unforeseen conditions, bad weather, materials supply, other work activities on site.

Price

Check what the given price includes and excludes. Consider potential impact of any provisional sum items or unknowns, such as for foundations and excavations.

Payments

What is the basis of payments: lump sum, or a schedule of rates? How are costs such as travel time, vehicle running and miscellaneous reimbursable costs covered? Are prices inclusive or exclusive of Good and Services Tax (GST)? Also, frequency of payments, payment approval process and whether retentions are deducted.

Information to be supplied by the client

Availability of relevant reports that provide useful background information, such as feasibility reports, test pits, water table depth, farm plans, information held by regional and district councils.

Consents

Who is responsible for obtaining resource and building consents, compliance with conditions, arranging for inspections and consultation?

Insurances

Level of professional indemnity, works and public liability insurances to be provided by suppliers engaged. When will the farm owner commence insurance coverage on the new asset?

Disputes

If an unresolvable disagreement arises is there an agreed disputes procedure such as appointing an independent engineer to contract, mediation, or arbitration?

Health and Safety

Who is preparing the overall Health and Safety Plan which integrates all the site activities? Roles and responsibilities, including monitoring and reporting on site?

At Completion

What signoffs are required, what is the defects period (if any), what constitutes practical completion and under what conditions can the farm owner start using the site?

Warranties/Guarantees

What is actually covered and for what duration. Any conditions or limitations on these?

1.3 Role of the project manager

An experienced PM can remove many of the headaches involved in the coordination of activities such as consents, subcontractors, inspections, and resolving issues as they arise. Other advantages include:

- The professional knowledge, expertise and networks to other specialists if their input is required
- Reducing the technical, contractual and financial risks. For example ensuring payment claims are processed on the agreed contract basis in a timely manner.
- Reducing the risk of supplier and contractor disputes by proactively managing issues as they arise
- Monitoring site Health and Safety and ensuring legislative requirements are met
- Freeing the farm owner from a day-to-day involvement in the project.

When to engage a project manager depends on the type of PM the farm owner wishes to work with. If it is an engineer, quantity surveyor or other professional involved in design they need to be involved from the start. This provides continuity of knowledge and an understanding of the project's objectives as it progresses.

The importance of good communication between everyone involved in the project should not be underestimated. The PM is key to making this happen. The farm owner should have confidence that the PM is able to keep communication channels open between the designer, the building contractor, various subcontractors and affected parties to achieve the farm owner's objectives.

1.3.1 Ethics

Farm owners may have to rely on someone they don't know for significant services in circumstances where they may be unable to assess the expertise or diligence of the service. This amounts to a significant risk for them and this is why IPENZ and members of other professional organisations are required to avoid conflicts of interest and display expertise and trustworthiness. Ethical practice is not an optional extra; *IPENZ Practice Note 08 Engineers and Ethical Obligations* further describes these obligations.

2. Legislative Requirements

There are many legislative requirements that must be complied with when designing, constructing and operating dairy housing facilities. Table 2.1 provides a summary of legislation that may be relevant to such a project. It is not an exhaustive list and the designer should determine whether other legislation is also relevant for the proposed activity.

Table 2.1: Relevant Legislation

| Legislation | Possible Requirements | Regulatory Authority |
|--|---|---|
| Resource Management Act 1991 | Resource consent could be required for: <ul style="list-style-type: none"> • Earthworks • Size of the building • Setback from the boundaries • Effluent storage pond • Discharge of effluent to land • Stormwater disposal. | Regional or District Council |
| Resource Management (National Environmental Standard for Assessing and Managing Contaminants in Soil to Protect Human Health) Regulations 2011 | If the proposed area of the works has been subject to any activities identified on the Hazardous Activities and Industries List (HAIL), resource consent could be required | District Council |
| Heritage New Zealand Pouhere Taonga Act 2014 | If any archaeological evidence is suspected or encountered on site | Heritage New Zealand |
| Building Act 2004 | Building consent may be required for the construction of the building | District Council |
| Animal Welfare Act 1999 | Code of Welfare - Dairy Cattle June 2014 | Ministry for Primary Industries |
| Animal Products Act 1999 | NZCP1: Code of Practice for the design and Operation of Farm Dairies | Ministry for Primary Industries |
| Health and Safety in Employment Act 1992 | <ul style="list-style-type: none"> • Safety during construction • Fencing of ponds • Safe access. | Ministry of Business, Innovation and Employment |

Legislation, as referred to in this Practice Note (PN), is used as a descriptive term that refers to all acts, regulations and regulatory requirements as developed by New Zealand parliament and government bodies. It does not cover requirements of industry bodies.

Specific requirements for resource and building consents are explained more fully in the “Consents” chapter, but are summarised in Figure 2.1.

Figure 2.1: Resource and Building Consent Processes

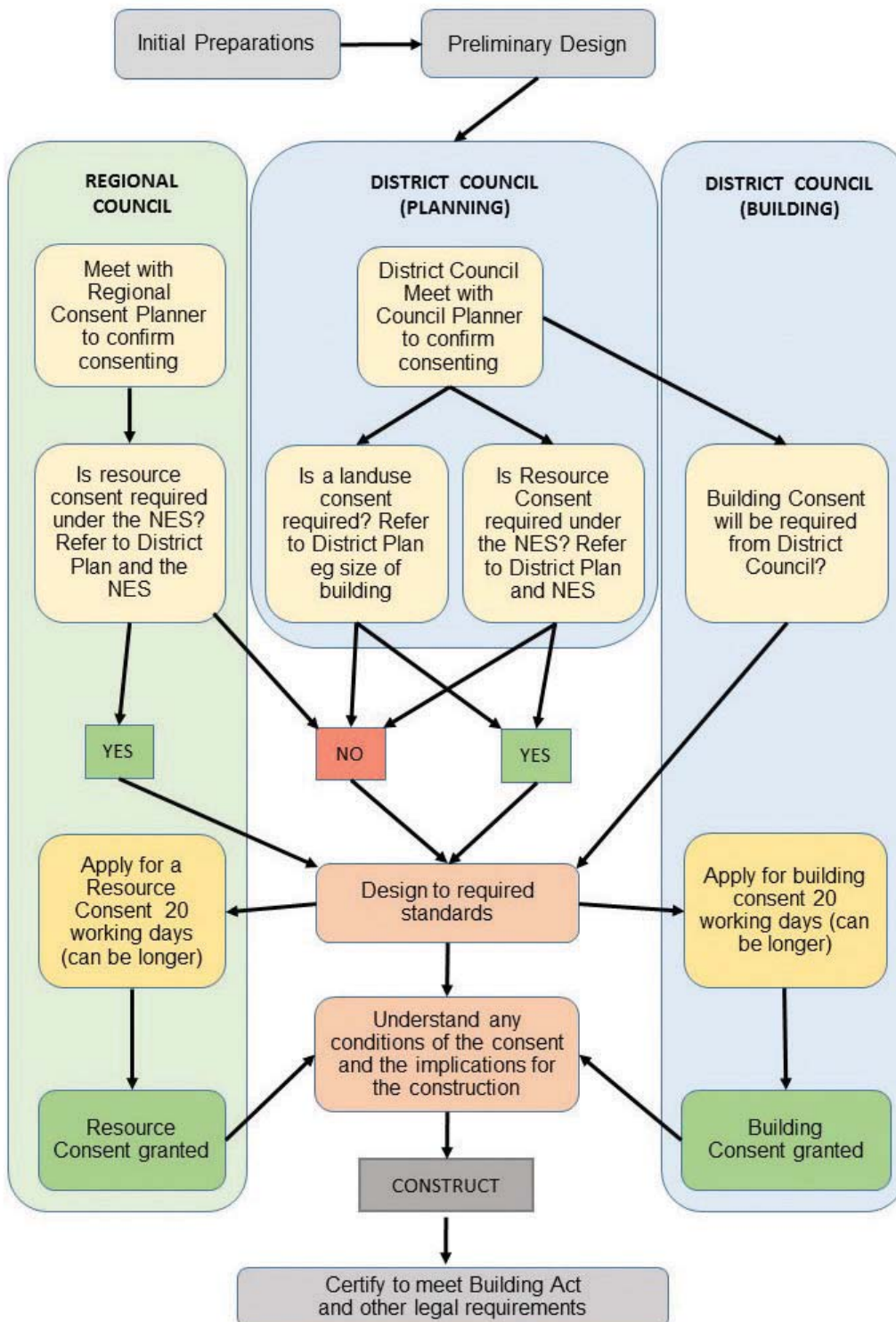

3. Estimates

Dairy housing is a major capital cost. Starting at the investigation phase and continuing through the design phase, a record of estimates for all costs should be built-up with contingency allowances applied to each item. As the design progresses, estimates can be further refined and contingencies reduced as price certainty increases.

If capital availability becomes a major constraint to the project proceeding, possible cost reduction strategies for a PM or farm owner might include:

- Research both the supply and installation costs of different building systems, for example different types of structures, roofing and cladding materials. Some systems will be more expensive to supply and install than others but their expected operational life will also vary. Cost versus expected life must be considered in the building system decision.
- Get price estimates from several competing suppliers. Importing directly from overseas may provide a lower cost option, but it should be confirmed that materials meet New Zealand regulations' performance requirements.
- Consider how much of the work could be undertaken by farm staff and how much should be given to contractors. However, building invariably takes longer and is more difficult than initially imagined. Experienced tradespeople will be able to work more efficiently.
- Find out what different builders and designers charge for their services. Ask to see similar facilities they have designed or built, and inquire what the cost was. Talk to their clients to find out if they were happy with the service provided.
- Prioritise what is important. Make a list of the "must haves" and what items can be eliminated or deferred to stay within budget.
- Engage an experienced designer who can identify where the major costs lie and has the skill to explore alternative options while maintaining acceptable levels of risk.

3.1 Value management

Value management (VM) reviews at the appropriate stages of design can assist in achieving more successful projects. Conversely, reviews undertaken too late can be ineffective and adversely influence programme and costs.

Generally, VM reviews are carried out at the end of the concept and/or preliminary design stages when the design has been coordinated between the design disciplines and there is a consistent basis for a cost estimate. The necessary revisions identified as part of the VM review can then be added to the start of the next design phase.

Research indicates that substantial savings can be made to the total project cost through good definition of the project at the initial design stages. If issues are properly considered and actions agreed, there is a greater likelihood that relationships will develop positively, greater assurance that the client's expectations can be satisfied throughout the project and a successful conclusion for all parties.

3.2 Certification

Financial institutions with an interest in the farm may require formal certification to ensure that exposure to financial, consenting and other risks have been appropriately identified and minimised. This can include design certification accompanied with an engineer's estimate prior to funding release and approval to proceed to construction.

A funding approval hold point in the programme can be beneficial as it provides a rational decision point to re-evaluate whether the project is still economically viable.

4. Project Phases

4.1 Investigating the options

The building designer needs as much information as possible to assist in meeting the farm owner's expectations around the function and performance of the building. The investigation phase provides an opportunity to undertake preliminary information collecting and conceptually develop where a building might be sited, what it might look like and how it might operate.

Some specific information that should be collected as part of the investigation phase is contained in the "Site Selection" chapter of this practice note.

4.2 Developing the design

Early in the design phase there should be a re-examination which will invariably involve the gathering of additional information to develop concept options. Some options are eliminated at this stage and the preferred option(s) is subsequently confirmed and developed into detailed designs taking the form of drawings supported by specifications.

Every project is different and there will be variations from any "standard" dairy housing design proposed by suppliers. Detailed site specific drawings must be provided so that all involved in the project can visualise what the completed building will look like and how it will operate. Drawings that allow for modification can be a tool to promote discussion and provide critical feedback to identify where improvements can be made.

With many dairy housing structures being "design and build", some burden falls on the construction supplier to provide minimal design so that some initial pricing can be developed. There are risks around this process to both the supplier and farm owner, these include:

- The farm owner receives a minimal design with an inaccurate cost estimate that might not reflect the final actual cost
- The supplier does not get any payment for their work if the farm owner does not accept the supplier or their design
- The farm owner uses the suppliers design to get proposals from other suppliers
- The farm owner does not get the best design for their farm because there is insufficient time spent in design development that comes from shared understanding and experiences.

For larger projects the design phase can be broken down conceptually into the following five sub-phases in Table 4.1. For smaller projects, these design phases are usually combined.

Table 4.1: Design Phases (Adapted from New Zealand Construction Industry Council - Design Documentation Guidelines)

1. Concept design for a dairy housing project involves developing a client design “idea” into what it might look like and what it could provide. It is a phase where design concepts are developed to establish the buildings feasibility for a particular site. This phase may also be used to better define what is possible for the farmer and at the same time assists the designer in understanding what the farmer actually needs. It often involves exploring some different approaches or options. At the end of this phase, the basic building blocks of the project become more defined in general terms.

Concept and preliminary design phases are often combined on less complex projects.

2. Preliminary design involves the further refinement of the preferred concept and assesses it against constraints such as available budgets, regulatory approvals and site limitations.

During this phase, the project concepts are developed into firm thinking, where sizes and spaces of facilities become better defined. The various design disciplines can be identified and coordination between them commenced. However, confirming individual details that do not affect key project elements is generally left for the design phase.

3. Developed design is the phase where the scope of each element in the design is now clearly defined and coordinated across those involved. Individual specialists prepare the necessary documentation to define the scope of all building elements.

The scope of the project is now fully defined and cost estimates can be prepared on an item-by-item basis.

4. Detailed design provides documents, such as drawings, that clearly define the design, specification and extent of all building elements. The design by this stage should be well coordinated with various disciplines. However, the documents produced may still not be able to be “built” from. Changes to anything but detail at this stage can be very disruptive and expensive and can result in unintended consequences, especially increased costs. Detailed design is the phase most commonly used to obtain a tender or quotation for the construction of the works.

5. Construction design is where the requirements defined in detailed design documents are integrated with changes that may occur during the tender and contract period. This can include feedback from tenderers who may suggest advantageous changes to the design that can contribute to, for example, improved buildability, reduced cost and decreased construction period.

Figure 4.1 and Table 4.2 provide some steps and checklists for guidance. A designer for example could use these to assist them in their design development management.

Figure 4.1: Investigation and Design Phase Steps

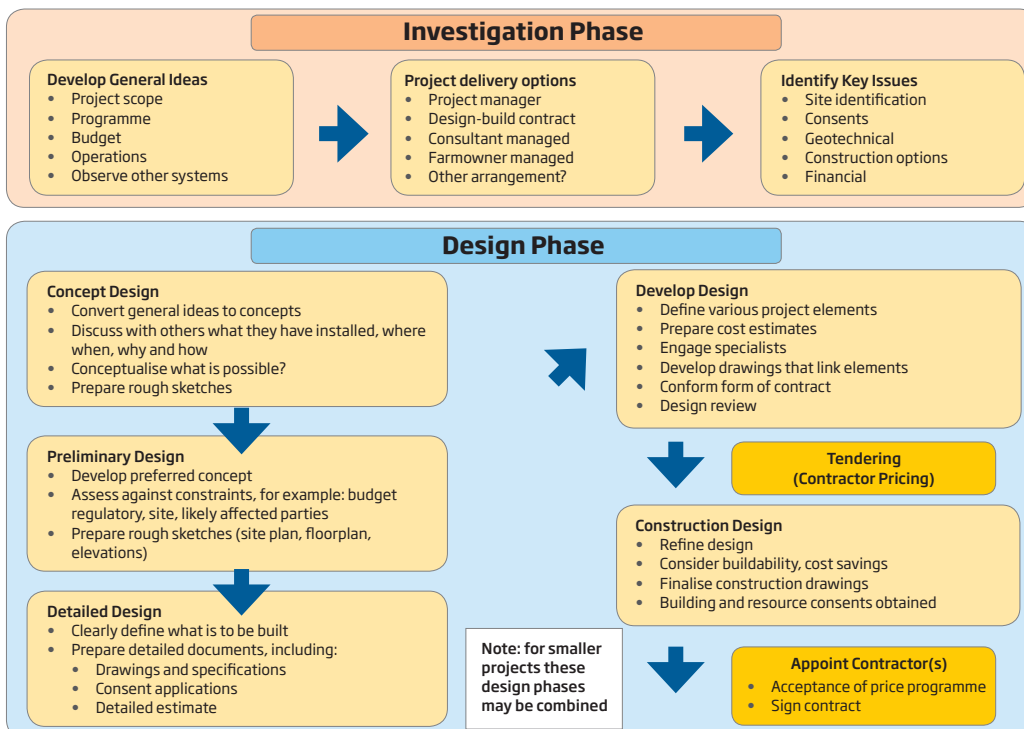

Table 4.2: Investigation and Design Checklists

| Investigation Phase Items | Outcomes and Deliverables | Commentary |
|---|---|---|
| <p>Inputs</p> <ul style="list-style-type: none"> • Client brief, including budget and programme • Arrange information collection: <ul style="list-style-type: none"> • Topographical survey • Buildings and services • Legal information • District plan rules • Existing resource consents. • Identify site constraints: <ul style="list-style-type: none"> • Power • Water • Geotechnical • Climatic. • Operational basics: <ul style="list-style-type: none"> • Seasonal or all year round • Maximum herd size • Floor layout options • Effluent management • Temperature and humidity. • Building concept options: <ul style="list-style-type: none"> • Building size: length, width and height, roof slope/pitch • Building materials, wall and roof cladding material • Effluent and drainage management • Ancillary structures and their location (e.g. feed and equipment storage). | <p>Outputs</p> <ul style="list-style-type: none"> • Agreed and signed off design brief with consultant/supplier • Report on existing facilities and engineering systems (if applicable) • Site options report • Conceptual drawings including: <ul style="list-style-type: none"> • Overall site plan • Floor layout plans • Elevations • Sections. • Process <ul style="list-style-type: none"> • Flow of inputs and outputs through the building (e.g. cows, feed, effluent). • Identification of specific building requirements (e.g. ventilation, water demand). • Rough order of cost • Identify potentially affected parties <ul style="list-style-type: none"> • Preliminary consultation with affected parties. • Submit concept design for a PIM to identify resource consent issues and to obtain existing conditions/ services information. | <p>Confirm</p> <ul style="list-style-type: none"> • Client brief and modify as necessary • Conditions of engagement • Roles and responsibilities for all participants, particularly procurement • What resource consents required • Programme • Drawings and detail required in them, for each phase according to project type • Specialists or consultants to be retained for advice and services at each stage (and the extent of the risks if not engaged) <ul style="list-style-type: none"> • Engagement arrangements • Programme • Fees • Responsibility for the design phase. |

| Design Phase | Outcomes and Deliverables | Commentary |
|--|--|--|
| <p>Inputs:</p> <ul style="list-style-type: none"> • Client approval of developed design • Client approval of developed cost plan and feasibility analysis • Resource consent obtained and all consent conditions adopted into design <ul style="list-style-type: none"> • Engineering completed for: <ul style="list-style-type: none"> • Building services • Fire engineering • Structural engineering. <p>Tasks:</p> <ul style="list-style-type: none"> • Attend regular design phase meetings with relevant parties • Coordinate and check each sub-consultant and other consultants' design and drawings. Are they integrated? • Consider buildability constraints and implications • Highlight significant or unusual health and safety risks that were identified in the design process • Prepare detailed drawings for: <ul style="list-style-type: none"> • Steel shop • Pre-cast elements • Pre-cut timber framing • Drainage • Steel shop drawings • Concrete work • Other fabricated items • Co-ordinate the design with detailed drawings required by other disciplines: <ul style="list-style-type: none"> • Equipment selection and technical data • Water supply systems, drainage • Fire protection • Electrical services including layouts and elevations • Review performance specifications. | <p>Drawings:</p> <p>Full set of drawings as per drawing register including:</p> <ul style="list-style-type: none"> • Site plan including datum, boundary definition and orientation, associated earthworks, landscaping and overhead services, drainage and showing all statutory legal title information • Floor layout including water troughs, effluent systems • Lighting and services fixtures • External elevations • Interior elevations • Cross sections and longitudinal sections • Roof plan with falls, gutters, rainwater heads and downpipes • Electrical/lighting outlet and switching plan • Plumbing layout and schematics • Construction details at all typical and non-typical locations cross referenced to plans and sections • Plans, sections of any access stairs, ramps, barriers and handrails, including to plant services areas. <p>Specifications - include:</p> <ul style="list-style-type: none"> • Building specification including preliminaries and all trade sections • Performance specifications for any works involving contractor design, including any specific testing and inspections required • Details of required coatings, finishes and surfacings. <p>Contractor Procurement:</p> <ul style="list-style-type: none"> • Registration and short listing of contractors • Conditions of tender, notices to tenderers and general conditions of contract • Contract documents. | <p>Procurement:</p> <p>It is important to understand how the suppliers, installers and contractors will be engaged as this will impact on the format of the documentation produced and the quality of the construction achieved. It may also be valuable to have input into the design from prospective contractors. The design consultant(s) may need to:</p> <ul style="list-style-type: none"> • Determine method of construction contract procurement • Determine form of conditions of construction contract • Prepare contract documents for client and contractor's signatures • Review and prepare documentation for tender with client, including insurance details, method of tender, bond, liquidated damages and tender protocols (where required) • Review tenders for compliance with tender documents and respond to technical options offered. <p>Also consider:</p> <ul style="list-style-type: none"> • Where appropriate, carry out discussion with a "preferred" contractor on construction methodology which may provide a better or lower cost option • Design may be sufficient to lodge for building consent part way through the overall design phase • Detailed design provides a level of documentation that clearly defines all building elements. These design details should be coordinated with other building related disciplines. • Ongoing maintenance requirement. |

5. Construction Phase

5.1 Introduction

The construction phase typically consists of three phases, being preconstruction, construction and post construction as illustrated in Figure 5.1.

Figure 5.1: Construction Phase Steps

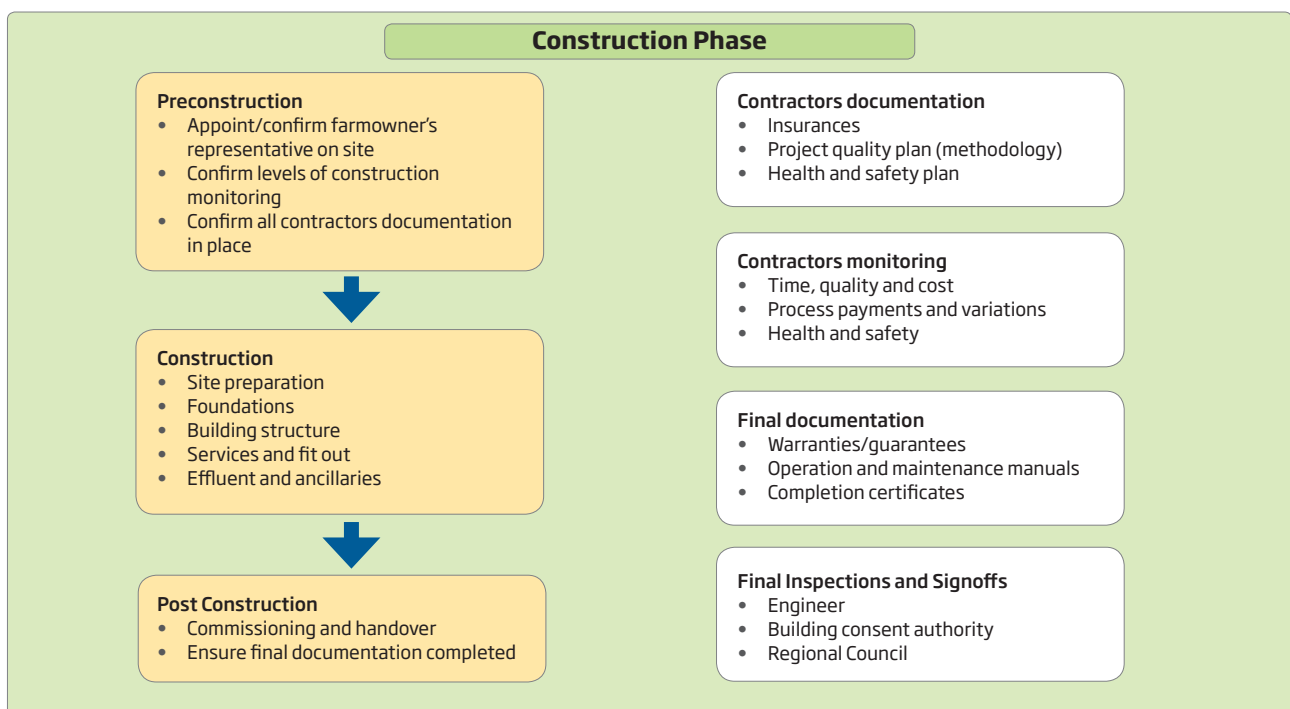

5.2 Preconstruction

5.2.1 Construction management versus monitoring

During construction, the project manager will need to observe onsite activities and confirm all specified requirements are being met. The level of construction management, which will vary depending on the complexity of the project, needs to be determined by the PM in consultation with the farm owner.

This construction management is undertaken by the project manager, whereas construction monitoring is the preserve of the designer.

Construction monitoring is typically undertaken by the design engineer (or their representative) to ensure "certain elements" of the design have been interpreted and constructed in accordance with relevant documents including drawings, specifications and consent conditions. Some monitoring activities may be delegated to the PM by arrangement.

The following section has been adapted from the IPENZ guidance document *Construction Monitoring Services* and is for general guidance only.

The appropriate construction monitoring level will be project dependent and influenced by the:

- Size and importance of the project
- Complexity of the construction works
- Experience and quality management skill of the contractor.

The five levels of construction monitoring service (CM1 to CM5) are detailed in Table 5.1.

Table 5.1: Levels of Construction Monitoring Service

| Level | Review | Comment |
|-------|--|---|
| CM1 | <p>Monitor the required outputs against the plans and specifications. Visit the work at a frequency agreed to review critical work procedures and/or completed plant or components.</p> <p>Be available to advise the contractor on the technical interpretation of the plans and specifications.</p> | <p>This level is only a secondary service.</p> <p>It may be appropriate:</p> <ul style="list-style-type: none"> • For the design consultant when another party is engaged to provide a higher level of construction monitoring or review during the period of construction, or • When the project works are the subject of a performance based specification and performance testing. |
| CM2 | <p>Review a sample of each important work procedure for compliance with the plans and specifications, and review a representative sample of <i>each</i> important completed work.</p> <p>Be available to provide the contractor with technical interpretation of the plans and specifications.</p> | <p>This level of service is appropriate for smaller projects of a routine nature being undertaken by an experienced and competent contractor and where a higher than normal risk of non-compliance is acceptable. It provides for the review of a representative sample of work procedures and materials of construction.</p> <p>The assurance of compliance of the finished work is dependent upon the contractor completing the work to at least the same standard as the representative sample reviewed.</p> |
| CM3 | <p>Review, to an extent agreed with the client, <i>random samples</i> of important work procedures, for compliance with plans and specifications, and review <i>important</i> completed work.</p> <p>Be available to provide the contractor with technical interpretation of the plans and specifications.</p> | <p>This level of service is appropriate for medium sized projects of a routine nature undertaken by an experienced contractor when a normal risk of non-compliance is acceptable.</p> |
| CM4 | <p>Review at a frequency agreed with the client, <i>regular samples</i> of work procedures for compliance with the plans and specifications, and review the <i>majority</i> of completed work.</p> | <p>This level of service is appropriate for projects where a lower than normal risk of non-compliance is required.</p> |

| Level | Review | Comment |
|-------|--|---|
| CM5 | Maintain personnel on site to <i>constantly</i> review work procedures, for compliance with plans and specifications, and review completed work. | This level of service is appropriate for: <ul style="list-style-type: none"> • Major projects • Projects where the consequences of failure are critical • Projects involving innovative or complex construction procedures • The level of service provides the client with the greatest assurance that the completed work complies with the requirements of the plans and specifications. |

The level of construction monitoring should be determined early in the design stage and will be driven by a number of factors, such as the consultant’s confidence in the proposed contractor.

To assist in this process, Table 5.2 provides rating values for various aspects of a typical construction project to assess an appropriate level of monitoring and inspection.

Table 5.2: Assessment Rating

| Criteria | K | Assessment | | | | Value |
|------------------------------------|-------|--------------------|------------------|----------------|----------------|-------|
| Project Status | K_A | Small 1 | Medium 2 | Large 3 | Major 4 | = |
| Complexity of work procedures | K_B | Routine 2 | Difficult 4 | Complex 6 | | = |
| Relevant experience of contractor | K_C | Inexperienced 6 | Experienced 2 | Certified 1 | | = |
| Consequences of non-compliance | K_D | Minor 1 | Moderate 4 | Serious 6 | Critical 12 | = |
| $KTOTAL = K_A + K_B + K_C + K_D =$ | | | | | | |

By relating KTOTAL (determined from Table 5.2) to monitoring frequency, the recommended level of construction monitoring (CM1 to CM5) by a PM can be inferred (see Table 5.3).

Table 5.3: Level of Construction Monitoring Review Based on Frequency

| KTOTAL (from Table 5.2) | Monitoring Frequency | | | | |
|----------------------------|----------------------|---------------|--------------|------------------|----------|
| | | | | | |
| 5-6 | | Sampling Only | - | - | - |
| 7-8 | | N/A | Weekly | - | - |
| 9-10 | | N/A | Twice Weekly | - | - |
| 11-12 | Secondary service* | N/A | N/A | Twice weekly | - |
| 13-14 | | N/A | N/A | Every second day | - |
| 15-16 | | N/A | N/A | Daily | - |
| 17+ | | N/A | N/A | N/A | Constant |
| CM Level | CM1 | CM2 | CM3 | CM4 | CM5 |

* This level of service is only appropriate when another party is responsible for undertaking the primary review of construction standards.

5.2.2 New Zealand standard construction contracts

The farm owner, the contractor(s) completing the physical works and the consultant need to have their roles and responsibilities clearly defined and documented prior to construction work commencing. The traditional way of accepting a contractor's verbal offer by way of a handshake with no written agreement in place, is not good practice. Given the cost of large dairy housing buildings and their fit out, and the costly risks involved with poor construction, it is not recommended that contractors be engaged in such a way.

NZS 3910 Conditions of contract for building and civil engineering construction is the benchmark for construction contracts that include the engineer in the administration of the contract.

Table 5.4: Role of Engineer (from NZS 3910 section 6.2.1)

The dual role of the Engineer in the administration of the Contract is:

- (a) As expert advisor to and representative of the Principal, giving direction to the Contractor on behalf of the principal, and acting as agent of the Principal in receiving payment claims and providing Payment Schedules on behalf of the Principal; and
- (b) Independently of either contracting party, to fairly and impartially make the decisions entrusted to him or her under the Contract, to value the work and to issue certificates.

NZS 3910 is written using terms that are well understood and has been tested before the courts. Construction industry leaders promote the use of NZS 3910 in its standard form as an equitable form of contract that is well tested, fair and provides certainty to all parties. It also provides a framework to value variations in a fair and reasonable way.

However, NZS 3910 can be quite complex. If the scope of works is relatively small then NZS 3915 Conditions of contract for building and civil engineering construction (where no person is appointed to act as engineer to the contract), is an option as it still provides the relevant contractual engagements and responsibilities of the parties but without the contract engineer's role.

NZS 3916 Conditions of contract for building and civil engineering construction – Design and construct is another option and is specifically structured for design and construct contracts, while NZS 3917 Conditions of contract for building and civil engineering – Fixed term is intended for maintenance contracts.

Table 5.5: Relevant New Zealand Standards for Building and Civil Engineering

| | |
|----------|--|
| NZS 3910 | Conditions of contract for building and civil engineering construction |
| NZS 3915 | Conditions of contract for building and civil engineering construction (where no person is appointed to act as engineer to the contract) |
| NZS 3916 | Conditions of contract for building and civil engineering construction – Design and construct |
| NZS 3917 | Conditions of contract for building and civil engineering – Fixed term |

All the New Zealand Standards listed in Table 5.5 include a “Schedule 6 – Form of Producer Statement”. This document should be filled in by the contractor to certify that they have completed the contract works in accordance with the contract. This provides some surety to the farm owner.

The inclusion of liquidated damages into the contract is appropriate for time or financially sensitive contracts.

5.2.3 Other forms of contracts and agreements

There are other forms of contracts and agreements circulating in the rural industry. These include:

- Federated Farmers “Contract for Services” for specific types of service
- Individual supplier developed contracts and agreements.

5.2.4 Contractor insurances

Contractor provided insurances are important and give reassurance to both the farm owner and the contractor if unexpected events occur. On projects, especially larger ones, the contractor should have the following insurances in place:

- Contract works
- Public liability
- Plant and machinery
- Motor vehicles
- Professional liability for design and build.

5.2.5 Contractor selection

There needs to be early understanding and agreement of contractor selection and management. Furthermore, where there are parts of the work which will be undertaken by others, it needs to be clearly defined whom they would be working for, that is, either the contractor or the farm owner.

If the farm owner has a preferred contractor and does not wish to approach any other, it is still important to supply the contractor with the following documents as a minimum:

- Construction drawings
- Schedule of quantities
- Written agreement (NZS 3910, NZS 3915, NZ 3916, or supplier agreement).

5.3 Construction

Some farmers may wish to project manage the construction work themselves, which can be appropriate for less complex projects. In this case, the consultant, typically an engineer or architect, may provide the design sign-off, but potentially the final construction review sign-off as well. The consultant should be careful with such arrangements, as they still need to be able to carry out periodic inspections and have an influence on the quality of construction as it proceeds.

To meet the individual expectations of farm owners, while allowing contractors and suppliers freedom to undertake construction using their preferred methodologies, the project management that will be required to deliver this will be necessarily different.

Items that the PM will need to be actively involved in during the construction phase include:

- Liaising and providing regular reports to the farm owner
- Confirming consent and regulatory requirements are being met
- Observing performance of construction contractors and suppliers. Is the work complying with the plans and specifications?
- Ensuring project programme is being met
- Arranging for additional contractors to be available as and when needed
- Dealing with suppliers and making sure materials are ordered and delivered on time
- Arranging for inspections by relevant professionals, for example, the designer or suppliers of technical equipment
- Answering questions that arise during building and clarifying anything in the construction documents with the contractors
- Knowing when progress payments are due and checking claims for payment
- Processing payment claim variations
- Arranging for timely inspections by council building inspectors
- Preparing amendments to the building consent where necessary
- Arranging for final inspection for the code compliance certificate
- Organising suppliers and contractors to undertake remedial work as required.



Building frame construction

5.4 Post construction

5.4.1 Practical Completion and Defects Liability Certificates

For all contracts, it is recommended that a Practical Completion and a Defects Liability Certificates are issued. The process for issuing them is described in the relevant New Zealand Standard used in the development of contracts.

The engineer or PM should assess that all of the following items have been attended to:

- All work specified or scheduled in the contract documents completed
- Resource and building consent requirements met
- Farm owner satisfied with the completed construction.

A defects liability period should be used to provide a mechanism for the repair of defects not obvious at the completion of the physical works. A period of 26 weeks should be adequate.

5.4.2 Producer statements

The producer statement process is intended to provide building consent authorities (BCAs) with reasonable grounds for the issue of a building consent or a Code of Compliance Certificate without having to duplicate design or construction inspection completed by others. The three categories of a producer statement are:

- PS1 - Design
- PS2 - Design review
- PS4 - Construction review

In addition an often recognised form for physical works construction can be found in standard conditions of contract, such as in NZS3910, Schedule 6: Form of Producer Statement - Construction.

These statements should also be appropriate to meet engineering requirements of District Councils and should meet certain certification requirements under the Resource Management Act 1991 (RMA), for example earthworks.

5.4.3 Warranties

A product warranty is usually a written promise to replace or repair a product or work, if necessary, during a specified period. Product warranties only apply when voluntarily offered by the manufacturer, installer or other business providing the product. These types of warranties are based on either statements made by, or a contract with, the person or company providing the product or service. The party providing the warranty usually decides the warranty period as well as the terms and conditions for the warranty. Any warranty should also detail what is not covered and some may require a maintenance programme to be adhered to for the warranty to remain valid.

To obtain the benefits of warranties the farm owner should be specific prior to construction concerning what warranties are expected on the products and services they are purchasing.

References

Association of Consulting Engineers New Zealand (ACENZ)

Client Information Sheets (Series of 5)

[www.acenz.org.nz/Content24.aspx#Client%20Info Sheets](http://www.acenz.org.nz/Content24.aspx#Client%20Info%20Sheets)

- *CIS 1: Professional Service Contracts* - Why clients should limit the liability of their consulting engineer
- *CIS 2: Professional Service Contracts Part 2* - Why clients should avoid non-standard conditions of contract for professional consultants
- *CIS 3: Understanding the value of consulting engineering services*
- *CIS 4: Changes in the CCCS Document (Conditions of Contract for Consultancy Services)*
- *CIS 5: Producer Statements* - What is a producer statement

Other Client Resources

www.acenz.org.nz/Content24.aspx#Other%20Resources

Conditions of Contract for Consultancy Services (CCCS)

(These are example contracts for general use between clients and consultants for procuring and providing consulting services.)

Design Documentation Guidelines

(The building sector, through the New Zealand Construction Industry Council, has developed a set of guidelines that clearly define the various design stages possible in a building project.

Comprehensive checklists give the range of services available. These guidelines should be of benefit to clients who wish to discuss their particular needs with builders, engineers and others involved in building projects.)

IPENZ

Construction Monitoring Services

www.ipenz.org.nz/ipenz/forms/pdfs/Construction_Monitoring_Services.pdf

Engineers and Ethical Obligations IPENZ Practice Note 8

www.ipenz.org.nz/IPENZ/forms/pdfs/PN08_Ethical_Obligations.pdf

Guidelines on Producer Statements

www.ipenz.org.nz/ipenz/forms/pdfs/PN01-Guidelines-on-Producer-Statements.pdf

Conditions of Contract

www.ipenz.org.nz/IPENZ/Engineering_Practice/Conditions_of_Contract.cfm

(Two forms of contract are available to engage an engineer to perform consultancy services. Both documents are available to use free of charge by both engineers and the public.

Conditions of Contract for Consultancy Services 2009 [also called the Long Form Contract] - have been developed to apply to a wide range of consulting services and for most types of projects. The General Conditions of Contract can be amplified or adapted when required to suit particular engagements by use of the Special Conditions.

Guidelines for interpreting the Conditions of Contract for Consultancy Services [PDF, 178 KB] - published June 2005

Short Form Agreement - the single-sheet short form agreement is suitable for engagements in many fields of engineering. The Model Conditions on the back encompass both domestic and commercial contracts.)

Federated Farmers of New Zealand

Contract for Service

<http://shop.fedfarm.org.nz/c/29/contractors>

Chapter 2
Floor Plan

1. Flooring

1.1 Introduction

When cows move around they must have confidence that they can walk without risk of slipping or sustaining injury. Cows will also have designated lying areas that must provide comfort. Furthermore, no matter what type of building structure is constructed, the effluent produced must be captured, contained and disposed of while meeting environmental regulations. Code of Welfare minimum standards relevant to flooring are included in Table 1.1.

Table 1.1: Extract from Dairy Cattle Animal Welfare (Dairy Cattle) Code of Welfare 2010

| Minimum Standard No. 9 - Housing Cows and Calves |
|--|
| a) Dairy cattle must be able to lie down and rest comfortably for sufficient periods each day to meet their behavioural needs |
| b) All fittings and internal surfaces, including entry races and adjoining yards that may be used by the housed animals, must be constructed and maintained to ensure there are no hazards likely to cause injury to the animals |
| e) All sharp objects, protrusions and edges, including damaged flooring likely to cause injury to dairy cattle, must be removed, repaired or covered. |

The floor surfacing type should be determined by balancing the factors of:

- Intended longevity of the surface
- How the surface will be kept clean
- Effluent capture
- Cow comfort.

Different surfaces within the housing facility will have different uses and need to be designed for their particular function. These can include calving areas, walking surfaces, central passageways or feed tables, feed, feeding and connecting passageways and vehicle access. Note that:

- The terms passageway, alley and lane all have the same meaning
- A feeding passageway is where cows stand to eat, whereas the central passageway, or feed table, is the area feed is delivered onto. The central passageway is where tractors and mixer wagons drive to deliver feed. All three may require different surface finishes.

There is a variety of dairy housing types in New Zealand. The two most common dairy housing system types are generally described as loose housed (see Figure 1.1) and freestall (see Figure 1.2). At the smaller scale these are often simple covered feed and stand-off pad structures, but at the larger scale they can be very complex structures designed over a floor plan for a specific type of farm dairy operation.

DairyNZ's booklet *Dairy cow housing - A good practice guide for dairy housing in New Zealand* (GPG) will further assist the reader in understanding factors that affect cow comfort and therefore relevant design aspects when considering cow housing system options.

Figure 1.1.1 Loose housed system

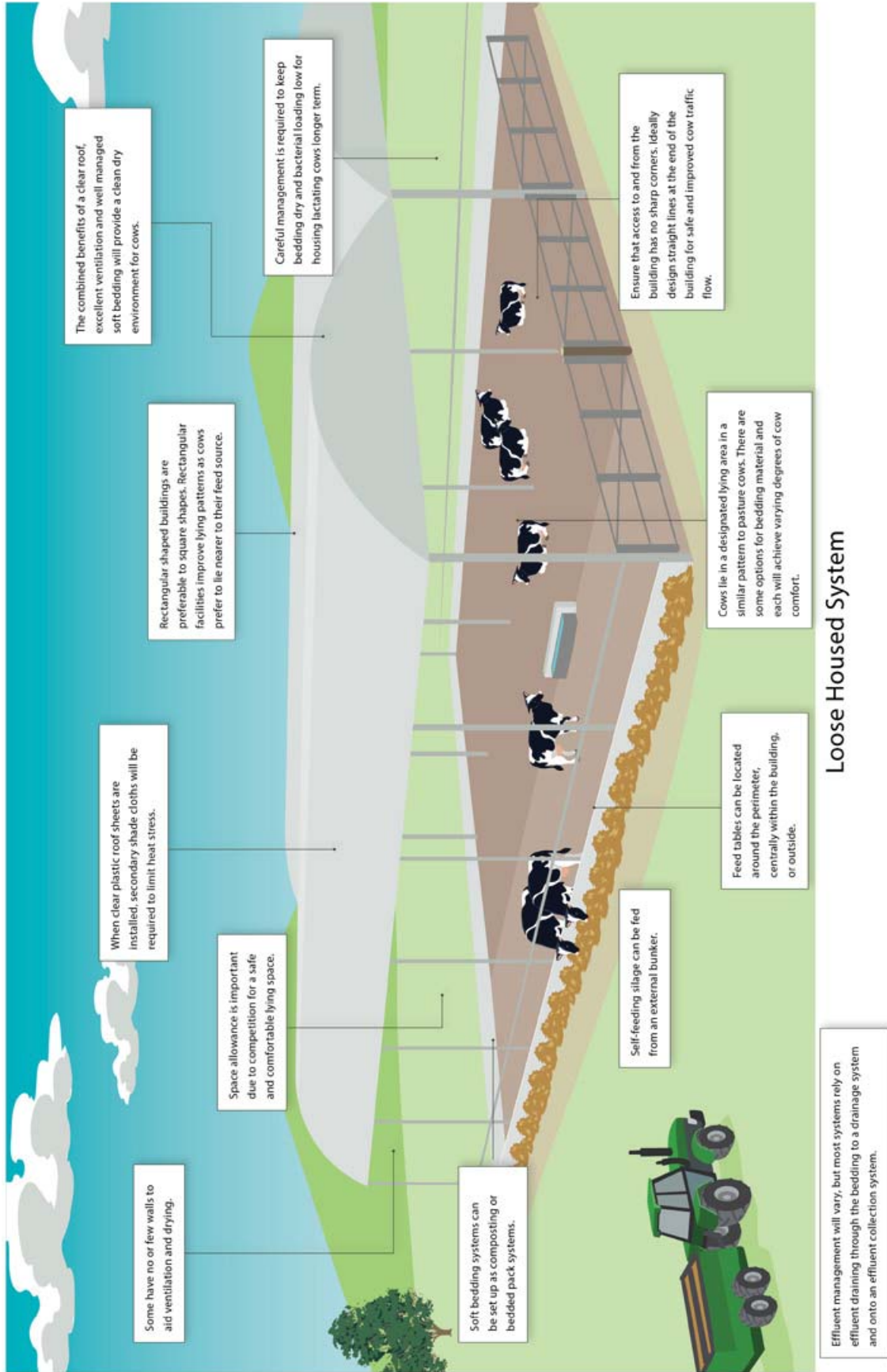

Loose Housed System

Figure 1.2 Freestall system

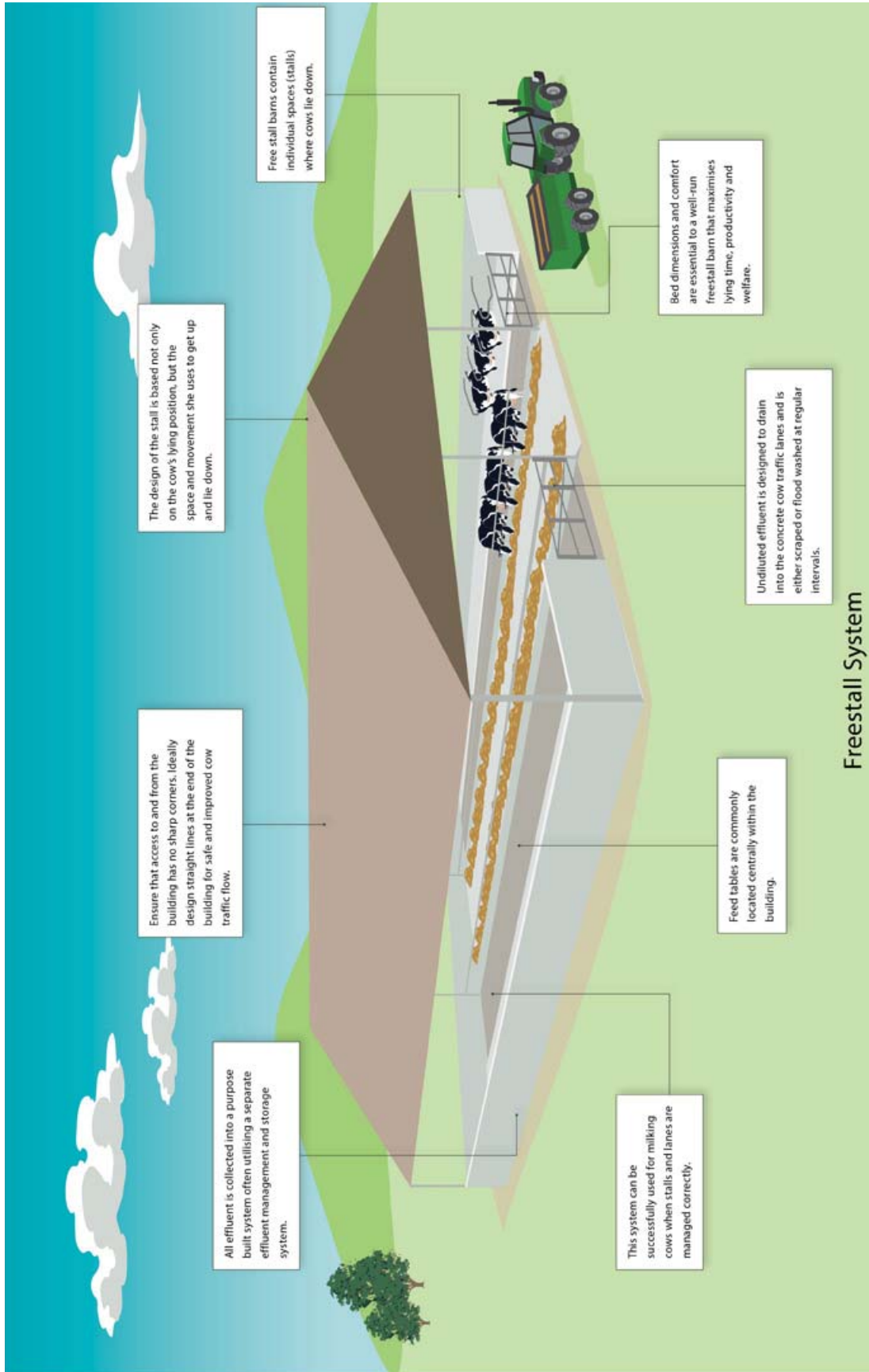

Freestall System

2. Dairy Housing Options

2.1 Feed and stand-off pads

Feed and stand-off pads are used for short periods to withhold stock from grazing and to minimise damage to pasture during wet periods. Often these facilities have covered roof structures to reduce the risk of heat stress in hotter months and provide dry feed in the colder/wetter months.

FEED PADS

These are a hard surface area normally located next to the farm dairy where stock can be held for a short period of time (two to three hours), either before or after milking, and provided with supplementary feed. Feed pads are usually included in a farm system to allow feeds, other than pasture, to be fed out with higher utilisation than paddock feeding. They are not ideal for holding cows for long periods of time because of the hard surface and limited space per cow. Rubber matting may be beneficial if cows are held on a feed pad for extended periods.

STAND-OFF PADS

These are specially built areas where cows can be taken off paddock for periods of time. Stand-off pads, also known as loafing pads, are primarily used during wet conditions to protect soils and pastures from damage, and in autumn to reduce urine deposition on paddocks. They can also be used in times of summer drought to take pressure off pasture. Stand-off pads are constructed from free-draining material such as bark or woodchips. If cows are held for extended periods (up to twenty hours per day), they need enough space to lie down. There is normally no provision for stock feeding while the animals are on the pad as they get their feed from short periods of grazing before being moved back onto the pad.

For all these facilities, effluent must be contained and drinking water provided.



Covered feedpads



Covered feedpads

2.2 Loose housed systems

Loose housed systems (see Table 2.1 for relevant sections in DairyNZ's *Dairy cow housing - A good practice guide for dairy housing in New Zealand (GPG)*) are often similar in bedding material and layout to that of a covered stand-off pad. However, cow space allowance has to be much larger because cows are held for extended times during which they need to move around and lie down. These facilities are suitable to milk from.

The base layer below the upper soft bedding is commonly concrete slats or bedding material.

Table 2.1: GPG Relevant Sections - Loose Housed Systems Design

| GPG Section Reference | |
|-----------------------|---------------------|
| 3.1 | Bedding area design |
| 3.2 | Bedding materials |
| 3.3 | Drainage |

SLATTED FLOOR

This loose housed type is a fully covered facility, usually with a plastic film over a frame type roof and a concrete slatted floor covering an effluent holding bunker large enough to hold the effluent for extended periods. Some have rubber matting covering the concrete floor, or may have bedding such as straw on top of the slatted floor to improve comfort. Some have individual spaces, freestalls, where cows can lie down. A strip of solid concrete along the outside lengths of the barn provides a feed face and tractor lane. Loose housed barns combine a feeding platform and an off-paddock facility for use during wet periods, or in autumn to reduce urine deposition on paddocks or for off-paddock wintering.

BEDDING MATERIAL

This base layer is a fully covered facility, usually built with plastic or steel roofing. The base is a soft bedding material such as straw, sawdust or woodchips, which will absorb some effluent. The material is added regularly into the bedding area while it is in use. There are many options for bedding material but the surface must be maintained in a dry state for hygiene and cow comfort. Soft bedding systems can be set up as composting (bed composts *in situ*) or deep litter systems (bed is removed and replaced annually).

Soft woodchips are preferred over sawdust because the small size of sawdust particles can hinder drainage and is difficult to manage when wet. The drier the woodchips, the longer the life span of the bedded pack. Macrocarpa woodchips cannot be used as a bedding material as these can cause pregnant cows to abort.

Most bedding material type housing has no or few walls to aid ventilation and drying. A strip of solid concrete along the outside lengths of the barn provides a feed face and tractor lane. Loose housed barns are usually intended to house animals for long periods of time during the winter, and when bedding is well maintained and space allowance is high.

EFFLUENT MANAGEMENT

Regardless of the base layer employed, all liquids must be fully captured and disposed of properly to prevent contamination of underlying ground and groundwater. Effluent management will vary but most operate by contained effluent draining through to an effluent collection point. Whatever system is employed, it must not let bed effluent run into the ground.

Some guidance to system design is provided in DairyNZ's *Standoff-pads: Your essential guide to planning, design and management* in section 2, "Effluent System Design".

COST CONSIDERATIONS

Loose housed systems tend to have a lower capital cost per cow than freestall barn. However, they usually have a higher running cost and larger footprint in square metres per cow, and can have higher environmental impact from disposal of soiled bedding.



Loose housed system

2.2.1 Layout and design

Some of the many considerations for the layout and design of loose housed systems are shown in Table 2.2. Figures 2.1 and 2.2 show a plan and section of an example layout.

Table 2.2: Loose Housed Layout and Design Considerations

| Design Consideration | |
|----------------------|---|
| Water | <ul style="list-style-type: none"> • Ensure water troughs are located out of bedded areas as cows can spill water when drinking and spoil the bedding • Fit splash back protection to water troughs to reduce possible water spill onto bedding and ensure that water dumped from the troughs during cleaning is kept well away from bedding. |
| Drainage | <ul style="list-style-type: none"> • As urine and faecal matter is added to the surface, providing sufficient permeability through the bedded pack and drainage flow along a sealed base is critical, as is the collection and disposal of this liquid beyond the bedded area. |
| Ventilation | <ul style="list-style-type: none"> • As additional moisture can increase the humidity, designing adequate ventilation into the building is critical. |
| Feed | <ul style="list-style-type: none"> • Ensure an adequate kerb or bund of sufficient height is constructed between the bedded area and concrete feeding passageway to prevent overflow of material • The passageway must also be wide enough to ensure that cows can pass along the back of cows that are eating. |
| Stocking rate | <ul style="list-style-type: none"> • If the buildings designed stocking rate is too high, the volume of urine and faecal matter added to the bed may also become too high overwhelming the bed's ability to dry. In operation, this could cause the bed to become unhygienic and unusable. |
| Bedding damage | <ul style="list-style-type: none"> • Cows should be able to access virtually the entire perimeter, and not be restricted to specific exit/entry points. |
| Building shape | <ul style="list-style-type: none"> • Maximise the ratio of perimeter to area to reduce bed trampling from cows walking through to the interior. This means designing lying areas as long rectangles rather than large squares • Avoid internal physical features such as columns that tend to channel cow flow and create internal tracks. |

Figure 2.1: Loose Housed System - Plan (Example Only)

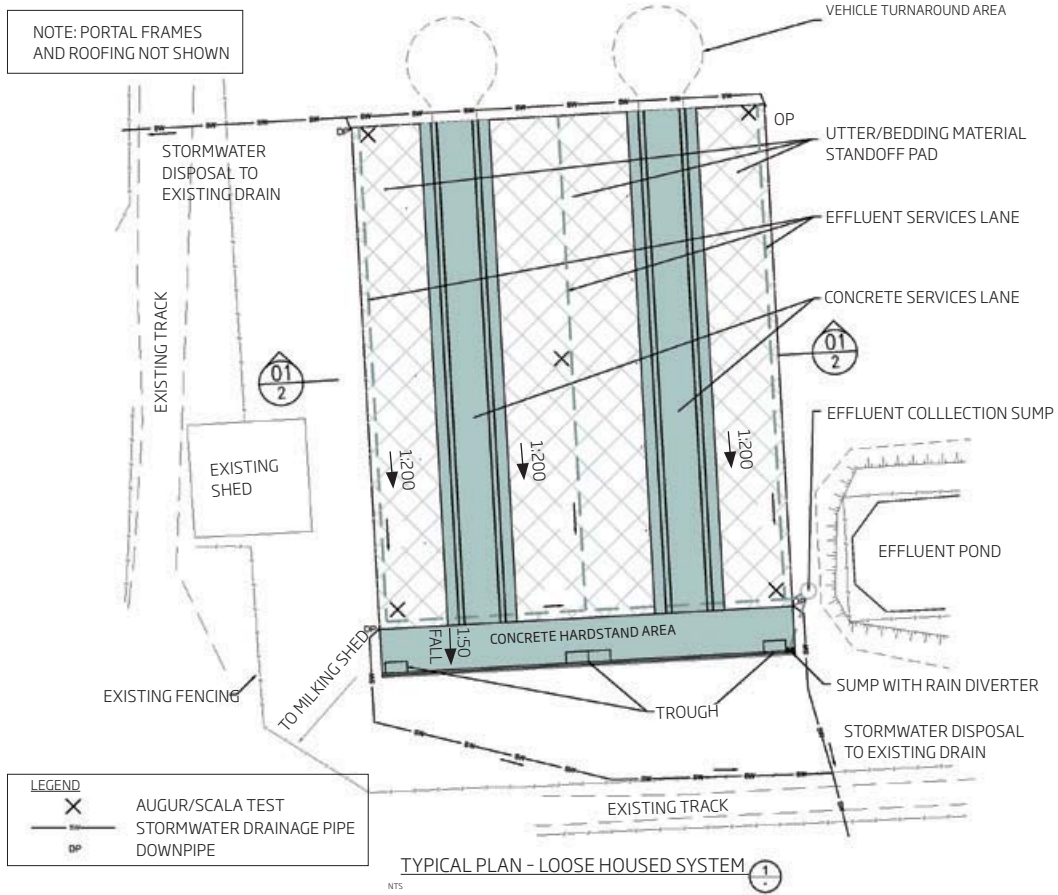
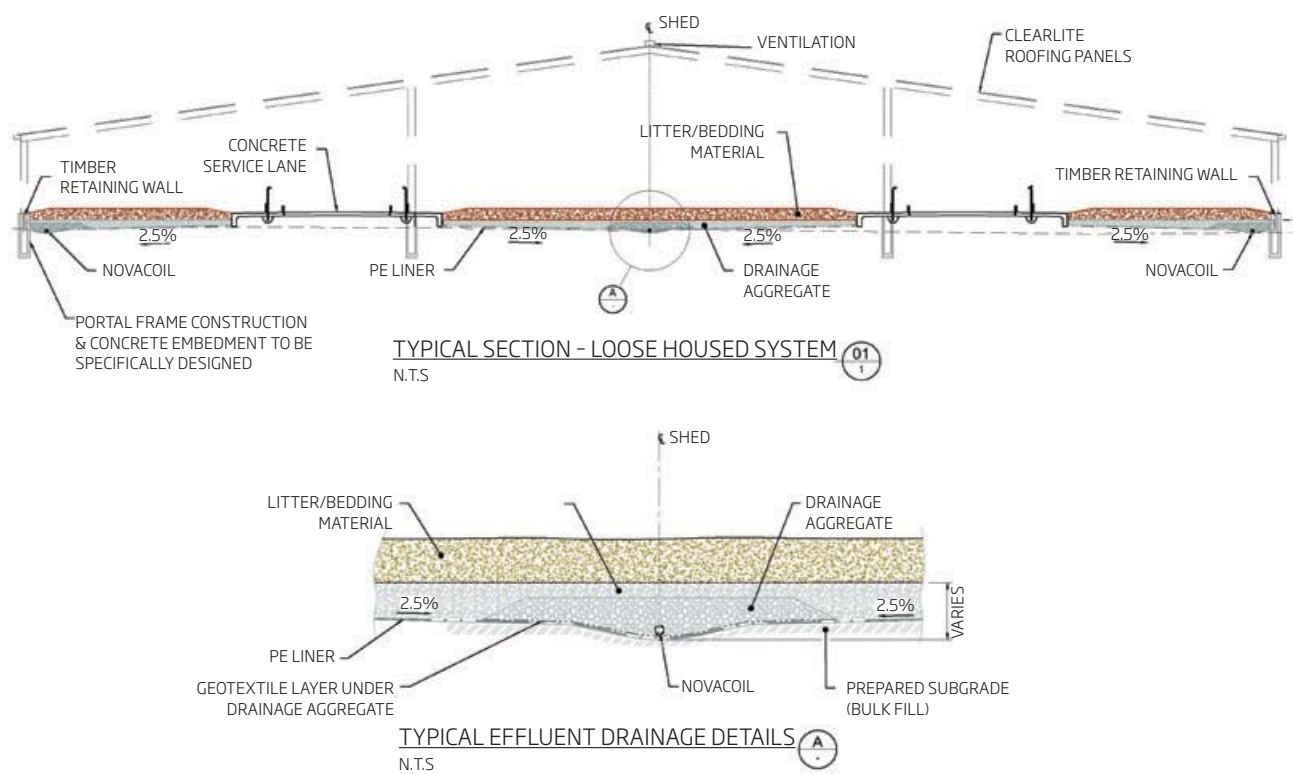

Figure 2.2: Loose Housed System - Section (Example Only)



2.3 Freestall

Freestall barns or buildings are a fully covered facility, typically built with steel roofing. They usually have a concrete floor area for cows to move around freely on and a softer surface area, for example rubber matting or mattress, that provides individual spaces (freestalls) where cows lie down. The controlled allocation of space reduces wasted building footprint, allowing more cows to be housed than in loose housed systems.

Cows get their feed from a central concrete feed lane. Passageways to deliver feed can be located either around the perimeter or centrally within the building. The freestall system can be successfully used for the daily milking of cows if stalls and passageways are managed correctly. They can be designed to house animals for long periods of time especially during winter months.

Stall layout is designed to deposit and drain manure and urine into the concrete cow traffic passageways, which are typically scraped automatically or manually, or flood washed throughout the day. All effluent is collected into a purpose built system often utilising a separate effluent pond.



Freestall housing system

Table 2.3: GPG relevant sections - Freestall Design

| GPG Section Reference | |
|-----------------------|-------------------------------|
| 4.1 | Layout and design |
| 4.3 | Passageway widths and layouts |
| 4.5 | Freestall dimension |
| 5.1 | Feeding system principles |
| 5.2 | Feed barrier design options |

2.3.1 Layout and design

There are numerous options for the layout and design of freestall barns, but the primary goals that need to be achieved are:

- Easy movement of cows between groups and within a group
- Easy travel of cows to and from the milking shed or robotic system, and pasture with minimal disturbance
- Hygienic entry and exit for feed delivery
- Easy access for cows to feed and water
- Sufficient feed face length
- Future expansion of the facility allowed for
- Effective liquid effluent and manure removal.

2.3.2 Passageways in a freestall system

Due to the nature of the design, various passageways within the facility have different functions. A common feature throughout should be the absence of internal walls except for cross-overs that often have water troughs fixed to them. Internal airflow is critical and internal walls will interrupt this.

Walls must be low enough for cows to see over. This also minimises shadows and helps with lighting evenness. If prevailing weather conditions allow, any perimeter walls should also be low enough to see over.

All passageways need to allow continuous cow traffic flow. Some passageways will have cows feeding in them, while others will have cows backing up into them out of stalls.

The main types of passageways, also known as alleys or lanes, are:

CENTRAL PASSAGEWAY

The central passage or feed table is used by the feed distribution vehicle to deliver feed to the feed barrier or troughs. Ideally, the design will include a turnaround loop outside the building so that the vehicle can circle and return without passing over cow contaminated surfaces. The feed vehicle should also have a cow-free route to the feed storage, otherwise vehicle wheels can collect manure, carry it into the central passage and flick it into food. The edges of concreted central passages must have low permeability and be smooth so the cow's tongue can lick up the feed easily.

Rejected feed is typically swept out along this passageway by a scraper blade mounted to a vehicle. There should be no sudden changes in feed barrier longitudinal profile, such as projections or columns that would interfere with a thorough cleaning out process.



Central passageway with post and rail feed barrier

FEEDING PASSAGEWAY

Feeding passageways are the alleyways where cows stand to eat. Cows are able to freely enter and exit the feed area while other cows are feeding. Typically, this passageway will also serve as access to stalls, so the width must allow a cow to reverse back out of its stall without affecting another cow feeding.

Feeding passageways are scraped clean and thus must be free of protrusions such as columns and fixings that could interfere with the scraper blade. Typically, a kerb is required to contain the effluent as it is scraped, and hence the beds are mounted on a raised level, the edge of which forms the kerb.

The floor slope depends on the length of passageway and system used for manure removal, typically zero to two percent. Most scraper systems work more efficiently in passageways with shallow or no slope.

Feed Barrier: At the feed face that separates the central passageway from the feeding passageway, there are a variety of feed barrier designs available including post and rail, yokes or headlocks, and strap barriers. A decision as to which system is to be employed needs to be made during the building design so that the required concrete walls, posts or other feeding related fixtures can be allowed for in floor slab design and construction.

STALL PASSAGEWAY

A stall passageway provides access only to stalls and as such can be narrower than the feeding passageway but still wide enough to allow a cow to pass behind another reversing out of a stall.

OUTSIDE FEEDING PASSAGEWAY

Some floor plans incorporate feeding passageways around the outside of the building. These require a roof overhang of sufficient width to protect the feed from getting wet and adequate clearance height for feeding out equipment such as mixer wagons.

2.3.3 Cross-overs

Cross-overs are positioned between the feeding and stall passageways at the end of each group of stalls. They eliminate unwanted passageway dead-ends and should be located at a maximum of 25 stall places apart, preferably at an average of 20 stall places.

Cross-overs facilitate cow movement and are the usual positions of water troughs and grooming brushes as these are the only locations that don't interfere with traffic, stalls, or scraping hardware. Positioning the water troughs on cross-overs keeps spilt water out of stalls. Cross-overs require side walls to shield adjacent bedding from projected faecal discharge and spilled water.

To provide for good cow traffic flow, a cross-over should have a minimum width of 3 metres, but if installing a water trough and brush allow additional width. This width allows space for cows to drink and groom, but also provides sufficient room for other cows to pass behind, as illustrated in Figure 2.3. Cross-overs are usually elevated or slightly ramped up above the level of the feeding and stall passageways to maintain a continuous kerb for passageway manure scraping. They are also sloped from centre to outer edges for drainage into the adjacent passageways. Cross-overs are not fitted with scraper systems and are usually flushed, hosed and scraped clean when the water troughs are dumped, typically while cows are away at milking.

Figure 2.3: Cross-over Layout

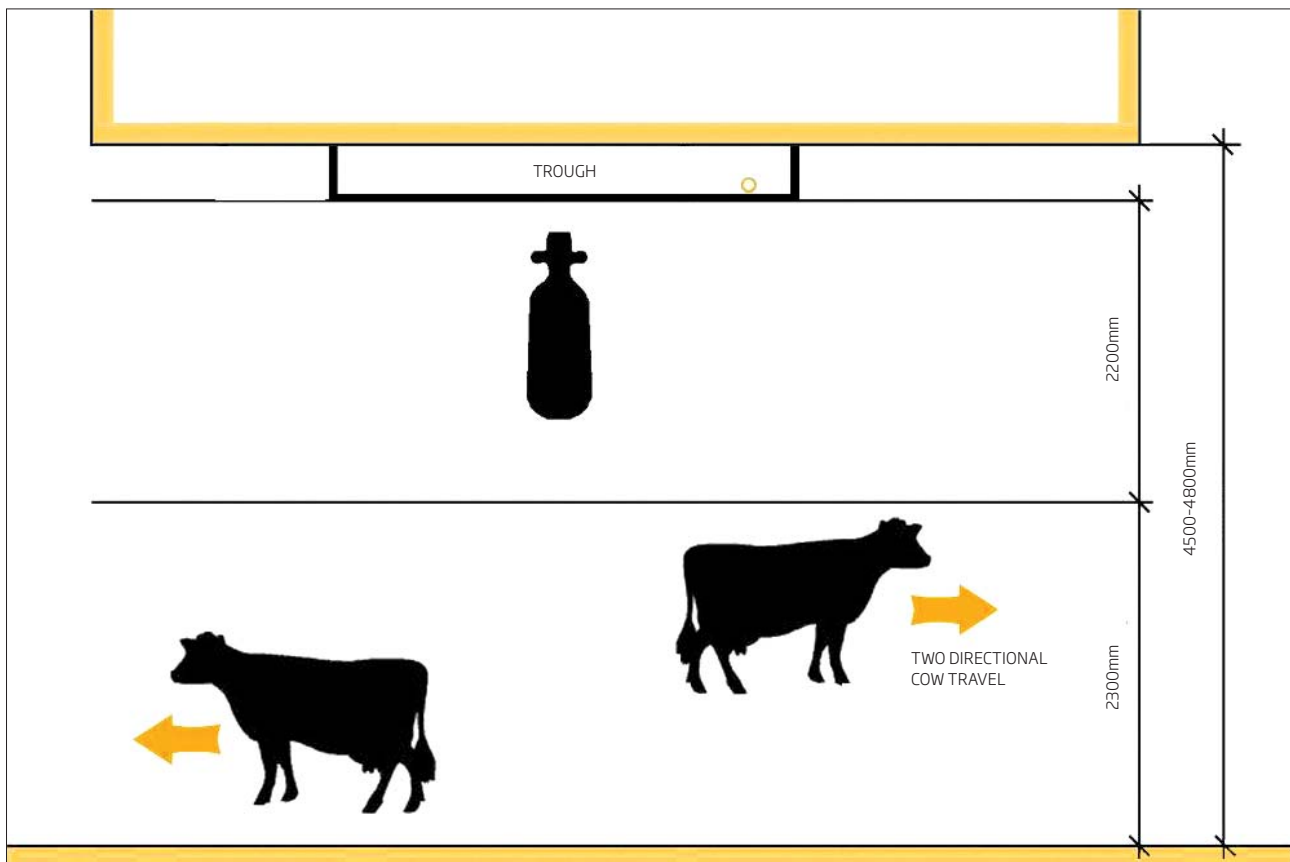

2.3.4 Free-range side exits

There is some industry thinking, although lacking sufficient New Zealand research yet, that access might be improved by adding occasional side exits aligned to cross passageways. This theory is supported by cows' natural tendency to stay inside a facility due to the easy availability of feed, water, grooming brushes, comfortable bedding and companionship of other cows. However, the added value of side exits would need to be offset against the cost of providing a sealed surface, typically a concrete apron or ramp, up to the exit from outside, and farm dairy effluent (FDE) capture and connection with the effluent system.

Research in the United Kingdom used by the Ministry for Primary Industries (MPI) shows cows make a choice primarily depending on feed and temperature. If it is better feed and temperature outside, cows will move there as a herd.

2.3.5 Passageway width recommendations

Passageway design widths tend to be a compromise between reducing construction costs and maximising cows movement space. Table 2.4 provides some guidance on minimum and optimum passageway widths, while Table 2.5 notes some factors that can affect passageway width design.

Table 2.4: Passageway Width Recommendations (Typical)

| Passageway Type | Recommended Passageway Widths (m) | |
|---|-----------------------------------|---------------------------------|
| | Minimum | Optimum |
| Central passageway (Feed table) | 5.5m | >6.0m |
| Feeding passageway only | 3.7m (1 cow passing behind) | 4.3m (2 cows passing behind) |
| Feeding passageway and to 1 row of stalls | 4.0m | 5.0m |
| Between 2 rows of stalls | 3.0m | 3.5m |
| To single row of stalls | 2.5m | 3.0m |
| Cross-over (no trough or brush) | 3.0m | 3.6m |
| Cross-over (with trough or brush) | 4.3m | 4.8m |
| <p>Note: Recommended passageway widths are based on the “typical” size of a dairy cow. Dimension widths shown are therefore only “typical” and provide a starting point for floor plan and layout design. Each designer will need to ascertain what widths will be appropriate for their freestall operation based on factors specific to the building layout and farm operation.</p> | | |

Table 2.5: Factors Affecting Passageway Width Design

| | |
|----------------------------|--|
| Central Passageway | <ul style="list-style-type: none"> • Dependent on maximum intended feed wagon size and feed “throw” distance to the feed face • Feeding to one or both sides of the central passage. |
| All Passageways | <ul style="list-style-type: none"> • For two cows walking past each other comfortably allow 2.4 metres space. <p>Note: Cows do not like to touch when they move past each other. Side stepping to avoid an oncoming cow should be discouraged as this can result in cows hitting dividers and posts, or disturb lying cows.</p> |
| Feeding Passageways | <ul style="list-style-type: none"> • Manure removal system, for example, automatic scraper channel and machine scraper widths, effluent bunker dimensions. • Sufficient width to herd cows in and out, especially in long buildings. |
| Other factors | <ul style="list-style-type: none"> • Cow breed and size • Building function, for example, robotic, conventional milking, wintering. |

2.3.6 Stall design

Stall width and length dimensions should be adjusted to meet the measurements of the specific herd size, or body weight, intended to be housed in the facility. Total stall length is the combined length of bed length plus head/lunge space length. Table 2.6 (adopted from GPG section 4.5) recommends the following stall design dimensions.

Table 2.6: Stall Dimensions

| Stall Dimensions (m) | Body Weight Estimate (kg) | | | |
|---|---------------------------|------|------|------|
| | 455 | 545 | 636 | 727 |
| Total stall length facing a wall | 2.44 | 2.44 | 2.74 | 3.05 |
| Full length of head to head stall | 4.88 | 4.88 | 5.18 | 5.18 |
| Stall width (centre to centre) | 1.12 | 1.17 | 1.22 | 1.27 |
| The length of a feeding cow can be approximated at 2.0m | | | | |

The GPG provides further dimensional information that should be considered in any freestall system design and reflects good animal welfare practices. Relevant sections are included in Table 2.7.

Table 2.7: GPG Relevant Sections - Freestall Design

| GPG Section Reference | |
|-----------------------|------------------------------|
| 4. | Freestall |
| 4.1 | Layout and design |
| 4.3 | Passageway widths and layout |
| 4.4 | Stall design factors |
| 4.5 | Freestall dimensions |
| 4.6 | Managing scraped passages |

2.3.7 Building size

Building floor area should be determined by multiplying the required length by width, after calculating the various length and width factors as described in Table 2.8.

Table 2.8: Freestall Building Dimensions - Main Determinants

| | |
|--------|--|
| Length | The multiplication of: <ul style="list-style-type: none"> • Width of feed face per cow adopted, and • Maximum herd size intended to be housed. |
| Width | The addition of: <ul style="list-style-type: none"> • Length of the stall to be adopted • Number of stall rows • Passageway widths. |



Three row stall (each side) with central passageway

2.3.8 Layout examples

To illustrate some options Figures 2.4, 2.5 and 2.6 show examples of layouts and are intended to provide general guidance only. The layouts are based on:

- (i) A design using "optimum" rather than minimum measurements
- (ii) A stall width of 1.2 metres for a "typical" cow size.

Designers should not rely on these configurations or on the measurements shown, but determine what would be appropriate for their site and dairy operations.

Figure 2.4: Three Row Stall System with Central Passageway
 252 stalls in 2 groups of 126, suitable to house 240 cows (5% additional stalls)

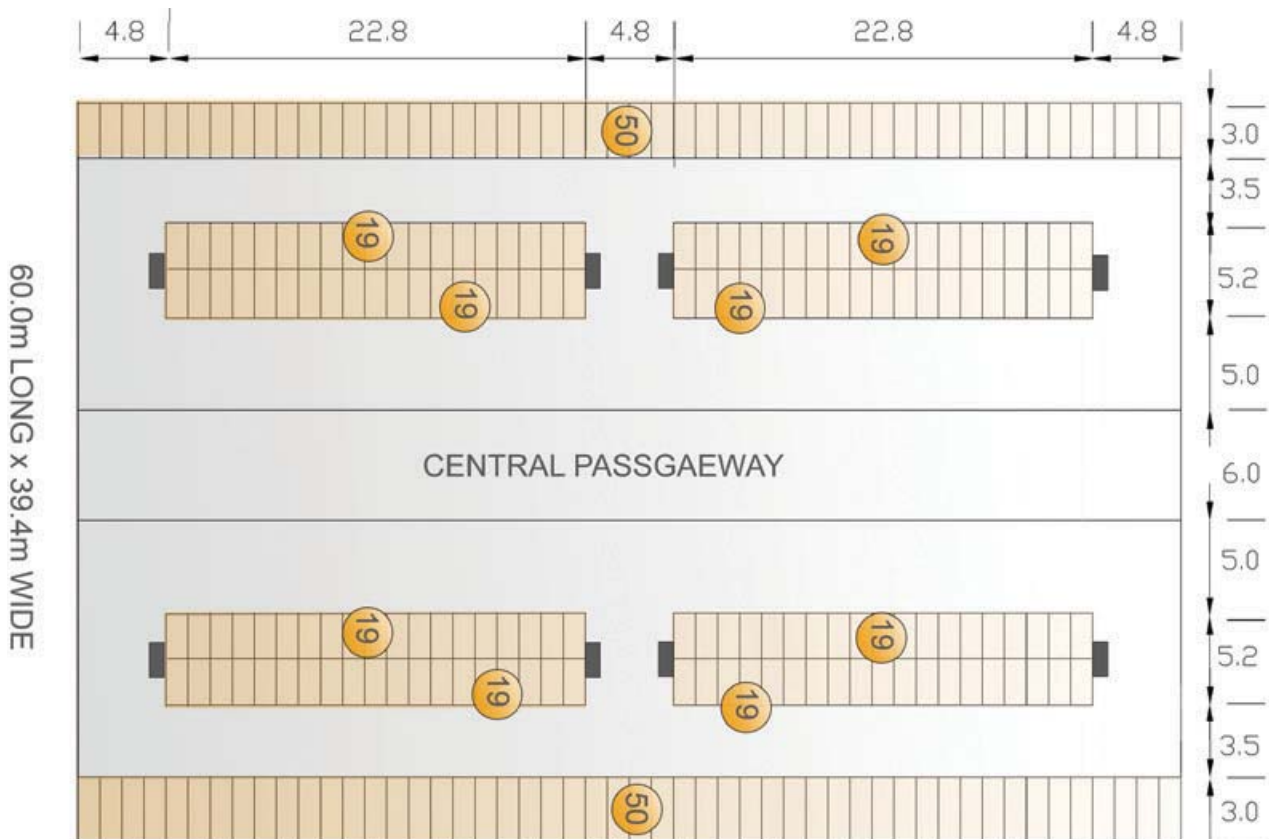

Figure 2.5: Two Row System with a Central Passageway
 176 stalls in 2 groups of 88, suitable to house 167 cows (5% additional stalls)

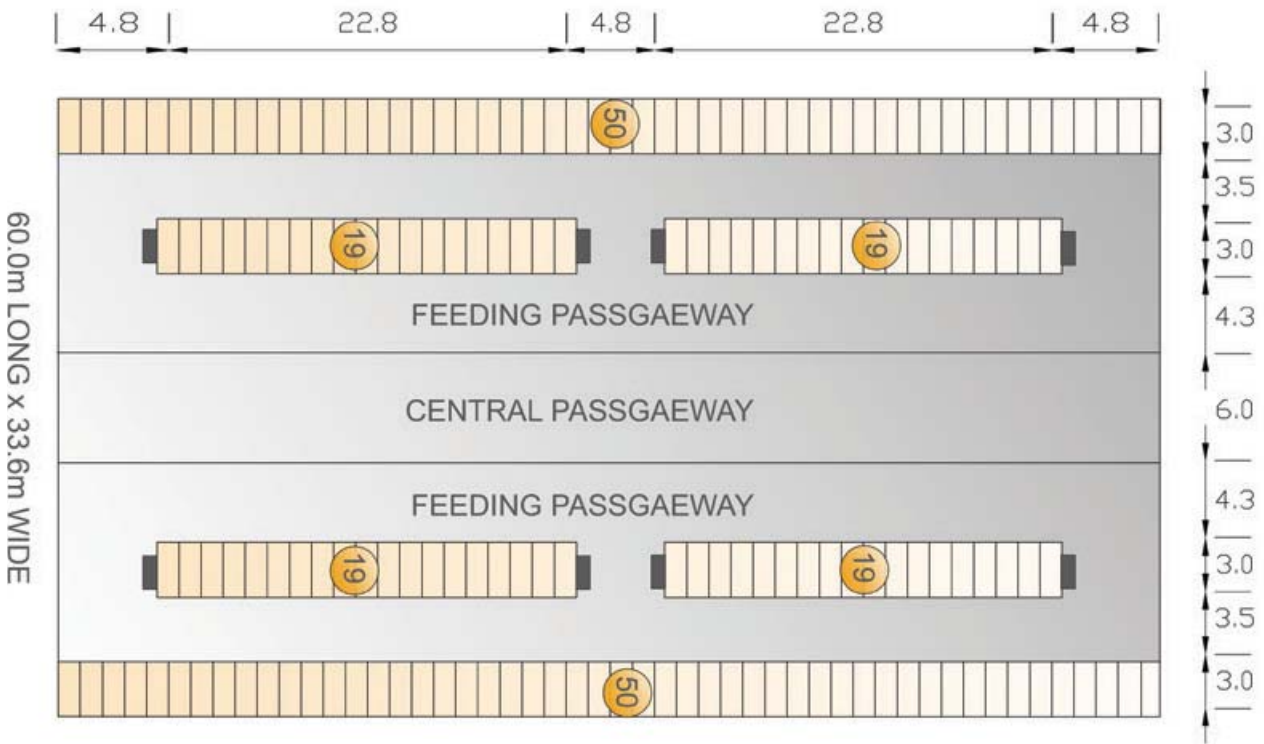
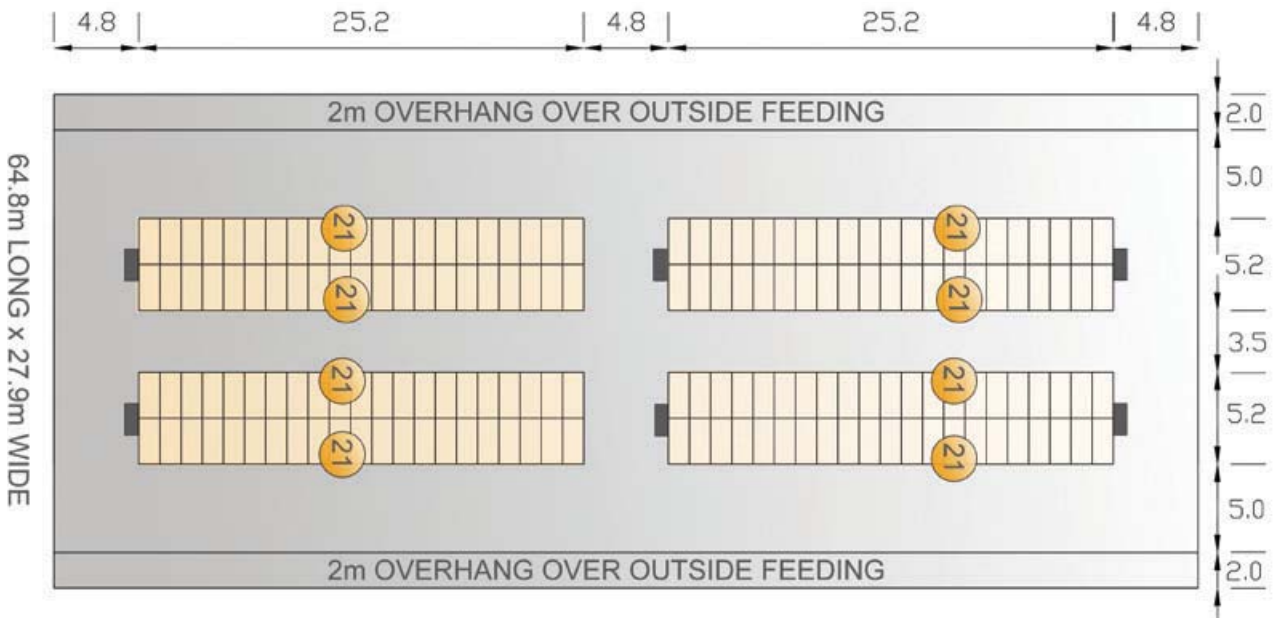

Figure 2.6: Two Row System with Outside Feeding
 168 stalls in 1 group, suitable to house 160 cows (5% additional cubicles)



2.3.9 Water troughs in freestall barns

Similar to loose housed systems, water troughs in freestall systems must also be located well away from the feed and/or shielded from splash by a low wall to avoid splash contamination.

Likewise, the trough must dump or drain water clear of feed. Troughs should ideally be wall mounted to assist cleaning around and under them. If floor mounted, design should ensure that the legs do not form a non-cleanable trap for manure, or interfere with scraping blades (vehicle mounted or on automatic scrapers).

Table 2.9: GPG Relevant Sections - Water Requirements

| GPG Section Reference | |
|-----------------------|-----------------------------|
| 6.1 | Drinking water requirements |
| 6.2 | Location of water troughs |



Water trough in a cross-over area with raised sloping floor

3. Concrete Floors

3.1 Concrete surfacing

Types of concrete flooring available including:

- Grooved concrete to provide a less slippery surface
- Slatted floors to capture effluent below
- Surface scraped floors, either, manual, machine operated, or automatic.

Concrete floors, irrespective of their surfacing type, must be anti-slip to allow confident walking and turning by cows without the risk of falling. In a continually wet floor environment, a broomed finish concrete surface is not recommended as it provides a more slippery floor than other available options and gives a more abrasive surface to cow's feet.

IPENZ Practice Note 27 Part 4 section 7.2 (pages 122-123) provides general information on concrete surfacing. The issue of floor slopes and alleviating slippery floors is discussed in some detail.

Factors affecting durability, and particularly abrasion resistance, need to be carefully considered when specifying the concrete to be used in floors. This is covered in *IPENZ Practice Note 27* sections 4.0 to 4.4 (pages 100-106). *IPENZ Practice Note 27* Section 9.0 Appendix (pages 125-148) includes reproduction in full of Cement and Concrete Association of New Zealand (CCANZ) *Information Bulletin: IB55 Concrete for the Farm*. This is a useful and practical guidance document and should be read by all involved in the design and construction of concrete for farm applications.

The "Building Structure" chapter of this Practice Note (PN) includes further information around critical concrete issues for dairy housing such as design, loading and durability.

3.1.1 Rubber matting

Rubber matting on concrete passage floors will reduce the pressure on cow's feet. Textured and slatted rubber mats allow the cow's foot to penetrate into the mat to provide grip and reduce slipping. Further comment around the advantages of rubber or other soft layer being used over concrete from a cow comfort and health perspective is outside the scope of this PN. The GPG does however make recommendations in its Flooring section.

3.2 Grooved concrete

The risk of cows slipping on concrete floors can be reduced with concrete grooving.

If an existing floor is to be improved, it is normal to adopt either parallel grooves if a cow flow is in one direction, or a pattern of regular squares similar to Figure 3.1 (a) or diamond shapes if the movement direction is more irregular. For long lanes with grades of less than two percent, grooves should be in the longitudinal direction to assist with drainage. For steeper slopes, groove orientation should be transverse, or cross slope, to the direction of cattle movement to improve slip resistance.

The most preferred option as shown in Figure 3.1 (b) is parallel grooves 10 to 12 millimetres wide and 6 to 10 millimetres deep, cut with diamond blades 80 millimetres apart. Shapes of lesser plan dimension increase the number of pressure points on a cow's foot without any added benefit in slip resistance.

Grooves on the concrete surface should run in the direction of any scraper travel, otherwise the blades will snag and quickly destroy the grooves.

Figure 3.1: Concrete Floor Grooving Patterns, (a) Square, and (b) Parallel
 (Note: This shows groove orientation for slopes >2%)

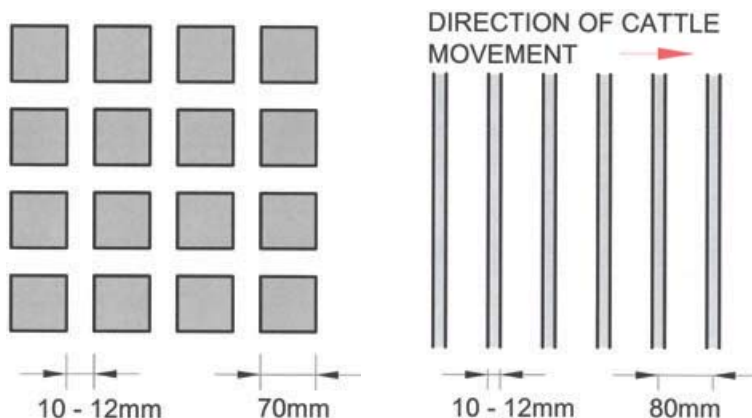

As grooves will decrease the effective depth of concrete cover over any reinforcement, the intended depth of the grooving should be allowed for when determining the chair height to support the steel reinforcement within the concrete. Minimum cover should be at least 50 millimetres for concrete that will be continuously exposed to chemical attack (e.g. from silage feed and dairy effluent acids), and 30 millimetres for structures that are not.

Another, less preferred, option is to form patterned grooves in high strength wet concrete using a tamping former or a grooving tool (one direction only). This option is adopted less because it is difficult to achieve a sharp square edge at the top of a groove. Successfully obtaining the required finish can be challenging, therefore, this approach should only be undertaken by experienced specialist concrete contractors with the requisite skills and equipment to undertake this work.

3.2.1 Provision for concrete replacement

With age, and especially with scraper wear and effluent attack, concrete slab surfaces will deteriorate and eventually crack. As lower strength concretes are more prone to premature surface degradation, higher strengths should be considered for longer life. Concrete of lower strengths which are subject to the highest attrition should be laid sacrificially. In other words, replacement of the concrete floor needs to be allowed for within the life of the building. In these situations, an impermeable membrane to contain any effluent must be placed under the concrete to protect the ground from contamination following cracking and inevitable leakage through the concrete.

Consider also using fibre reinforced concrete rather than steel mesh for easier removal. Furthermore, if the concrete slab is not tied into the neighbouring kerbs and walls, it can be removed more easily later. However, if the concrete floor is a structural element in the building's design and walls or columns are intentionally tied to the concrete floor then the building's structural engineer needs to be consulted.

3.3 Slatted floors

Slats in the concrete floor passageways allow drainage of effluent to a bunker beneath which negates the need for a scraper system. Every year or two, typically, the bunker grates are lifted and a front-end loader cleans out the bunker. The system relies on the manure and urine drying out so that it does not ferment. Wash-down opportunity is very limited as they are essentially a "dry" facility operation. Another option is storing the effluent in liquid form (with the addition of shed effluent if necessary) in the bunkers and pumping it out as required.

It should be noted that a build-up of slurry collected in below ground tanks where building walls are enclosed and ventilation is poor, may result in a build-up of waste gases such as ammonia, carbon dioxide, and hydrogen sulphide. Ammonia may begin to irritate mucous membranes at levels above 25 parts per million. Although carbon dioxide is not poisonous at levels above 3,000 parts per million, it can adversely affect cattle as it lowers oxygen levels. Hydrogen sulphide is highly toxic with levels above 50 parts per million known to kill cows. These problems are more likely to

occur in a “wet” system that incorporates underfloor effluent tanks that requires slurry agitation, for example while tanks are being emptied. Systems that hold manure for prolonged periods can also be prone to breeding flies.

DairyCo (UK) recommends that for a mature cow, the width of the slat should be around 140 to 160 millimetres and the spacing between slats 35 to 40 millimetres. For smaller cow breeds, the spacing should be reduced.

To provide a long service life, concrete slatted floors must be specifically designed for and constructed using high strength reinforced concrete, usually with appropriate additives. This is especially important if slatted floors are installed as precast concrete slabs that span across wide channels or bunkers beneath. Such slabs may need to be periodically lifted, in which case they will need to be physically robust to withstand these lifting and placing actions, as well as chemically resistant to withstand the acidic working environment of animal housing. Further recommendations on concrete supply and construction are included in section 9 “Concrete” of the “Building Structure” chapter in this Practice Note.



Slatted floor



Slatted covers over a cross-collection channel for scraped dairy effluent

3.4 Automatic scrapers

Many housing systems are constructed to incorporate automatic slurry scrapers that immediately remove dairy effluent. The scrapers either:

- Deposit the effluent slurry outside the building on hard standing area for collection by a tractor scraper, **or**
- Scrape FDE directly into a holding tank or pit outside the building, and channel or pump it into the farm effluent system.

Most scraper systems have an electrical cut-out, so if the manure load pushed exceeds a certain limit it will stop. However, the longer the scraper system the more waste the plough has to push and the less sensitive it becomes to the weight of a captured downer cow.

The practical maximum length for a scraped channel is 150 metres. However, beyond 100 metres, a more reliable option is installing a double plough system that scrapes from both ends of the building inwards to a cross collection channel across the middle of the building. The central passage part of this channel is enclosed to avoid the possibility of feed contamination.

Once the length of a building exceeds 200 metres, the cow traffic problems, such as lane widths, become unmanageable and construction of additional separate buildings is recommended.

The plough is pulled along the scraper bed using a steel chain or nylon rope powered by one or more electric drive units along its length. Steel chain can be quickly repaired if it breaks and links can be removed as the chain stretches with use. Nylon is lower cost, strong and can stretch when a force is applied suddenly and then return to its original length when the force is removed. Some industry suppliers recommend cutting or forming a recess into the scraper bed to house the chain and so reduce the likelihood of cows being caught in it.

4. Design Considerations

4.1 Sloped floors

There are two schools of thought as to whether or not concrete floors should slope.

SLOPED FLOOR

Large floors are rarely laid perfectly flat and invariably there will be some localised areas of effluent ponding from standing cows. Some floor slope (typically up to two percent) can provide positive run-off across the floor to a drainage channel and sump. Slope is essential if any part of the floor is exposed to rainwater.

FLAT FLOOR

Passageways with automatic scrapers should be flat or have minimal slope so the liquid in semi-solid effluent is not completely drained away from the solids as dried solids will adhere to the floor. However, a shallow fall in the direction of travel can reduce the depth of the puddle that the advancing scraper creates by letting it flow forward away from the blade. Cows have to step over the scraper and in doing so, wade through this puddle, so, a shallower puddle depth reduces the extent of foot contamination. Floors can also become more slippery as they dry out. However, in dry conditions, water can be sprayed on the surface to reduce the stickiness allowing cows to move more safely and scrapers to work more effectively.

For sloping sites, providing a flat floor may come at an additional cost due to the extra fill required under the floor area. However, the building slope is often dictated by the preferred orientation and layout of the building, not where the effluent has to go.

4.2 Entrance areas

When cows have been walking on standard outside raceways the small stones caught in their hooves can cause lameness. To reduce the stones carried by cows into the housed facility there are three main options available:

- (i) Lay a softer surface leading to the entrance. Materials such as bark chips, limestone, gravel or sand can be used. Spread for 100 metres leading up to the housing facility entrance.
- (ii) Install a footbath system that removes stones by washing them away with water immediately before cows step into the facility. This can also enhance hygiene by washing effluent from their feet, and provides an opportunity to add foot treatments.
- (iii) Construct a step barrier that removes stones caught in hooves as the cow lifts its legs to step over as illustrated in Figure 4.1. Step barriers also act as part of the nib wall helping to contain effluent.

Figure 4.1: Correct (and Incorrect) Nib Wall Design

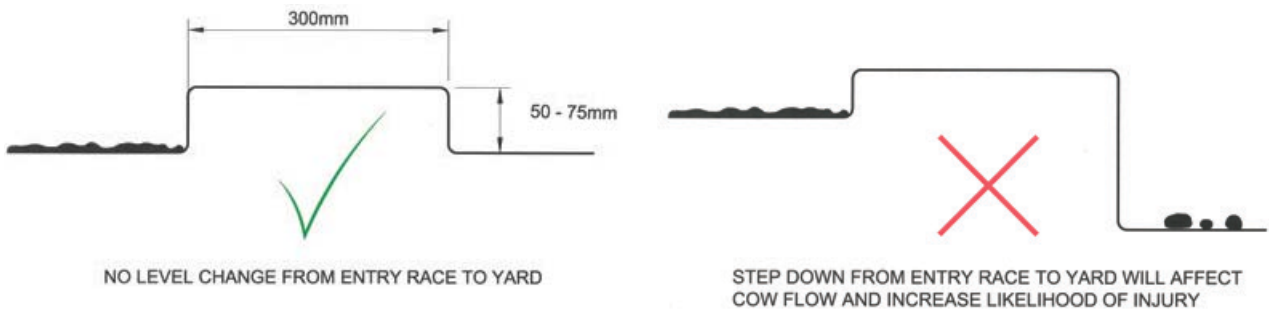

4.3 Floor cleaning

When the facility is occupied, all hard surfaced passageways need to be scraped or washed free of effluent on a regular basis throughout the day with cleaning options including those in Table 4.1. The removal of effluent is essential for cow health and hygiene. The method of removal needs to be carefully considered and incorporated into the design of the floor and building services.

Table 4.1 Concrete Floor - Passageway Cleaning Options

| Option | Advantages | Disadvantages |
|-------------------------------------|--|---|
| Scraping (Machine with operator) | <ul style="list-style-type: none"> • Lower capital cost | <ul style="list-style-type: none"> • High labour cost • Requires cows to be absent. |
| Scraping (Auto mechanical) | <ul style="list-style-type: none"> • No labour cost • Continuous cleaning operation. | <ul style="list-style-type: none"> • Ongoing maintenance • Risk of cow injury from scraper. |
| Flood washing | <ul style="list-style-type: none"> • Lower labour cost • Less splashing of feed and bed area than hosing • Potential use for green-water recycling. | <ul style="list-style-type: none"> • Higher capital cost • High water use • Manure accumulates in wide channels • Risk of splashing cows and lying areas. |



Flood washing

5. Layout

5.1 Accessibility

The general location of the housed dairy cows should be in close proximity to all other infrastructure related to the operation and management of the facility. There will be ideal minimum and maximum distances from these other structures, and hygiene constraints on traffic routes. However, usually, practical compromises will have to be made for site and other constraints. Layout planning for both current and future needs is key.

5.2 Supporting facilities

5.2.1 Feed storage

Locating feed bunkers close to the housed cows will reduce wear and tear on machinery and improve efficiencies in time taken to feed out. The route from feed storage to the central passageway should not cross cow traffic routes. Avoid contaminating vehicle wheels with manure.

Ensuring there is sufficient feed storage available for supplementary feed is key. It is important to plan for the future when designing these systems to allow for additions. Concrete aprons are generally included in front of the feed bunkers and surrounding the building to improve general hygiene and provide a clean surface for cows, machinery and the farm team.

Leachate from silage and other feed storage bunkers and bins must be contained and drained, or pumped, into the farm effluent system.

5.2.2 Effluent system

Ideally, the effluent system should be located in close proximity to cow housing structures to reduce the distance that effluent needs to be pumped and gravity fed away.

Where effluent bunkers are used, whether for underfloor manure capture, or for solids from mechanical or passive separation systems, ensure that there is ample manoeuvrability space for machinery when removing manure solids.

Any contaminated water seeping from manure bunkers must be returned to the effluent system.

Further information is contained in the “Effluent System” chapter of this Practice Note.

5.2.3 Milking facility

If the housed cows are to be milked, the location should be in close proximity to the cow’s visual route to and from the milking facility. The two are generally linked with concrete, or similarly constructed, races and these need to be wide enough for machinery and easy stock movements. This and any other stock route must not cross the milk tanker access road.

5.2.4 Bedding material storage

For facilities using soft bedding material, ensure replacement bedding is easily accessible and the storage design keeps bedding material dry.

5.2.5 Cow handling and vet facilities

Most dairy sheds and yards already include cow-handling areas. However, if a handling facility is going to be included in the design of the building it usually consists of a holding pen, forcing area, race, crush and dispersal pen. Additional insemination facilities are often required. Ideally, any stock handling areas should be sited on the flat or on a slight incline with the predominant direction of cow flow uphill. They also need to facilitate:

- Accessibility to remove and treat downer cows
- Facilities for dealing with lame cows
- Farm staff access within the facility itself.

5.3 Turning circles

Knowing the manufacturer and model of both the feed wagon and tractor unit at the outset is key in calculating the turning area required at both ends of the building. From this information, minimum turning circle diameters can be calculated and hence how much concreted outside area is required. However, to this minimum additional diameter distance need to be added to allow for:

- When the tractor unit operator overshoots and does not turn to full lock at the precise location when exiting the building
- Avoiding long term mechanical and tyre wear to the tractor unit by reducing the distance it is required to operate on full wheel lock.

Similarly, feed bunkers need to be suitably placed so they can be accessed by the feed wagon with the fewest number of turns.

A plan showing the proposed locations of the various supporting infrastructure should be drawn. This should include items such as feed bunkers, storage of other supplementary feeds, effluent system components, drainage features, cow entry/exit lanes, and fencing. Lines can then be superimposed on this plan confirming that the proposed turning circles do not conflict with site infrastructure. This approach is recommended to ensure a concreted area is constructed which is sufficiently large.

References

Department of Primary Industries Victoria

Guidelines for Victorian Dairy Feed Pads and Freestalls - First Edition

www.dairyfeedpads.com.au/content/useful-documents

IOWA State University - Mid West Plan Service (MWPS)

Dairy Freestall Housing and Equipment

www-mwps.sws.iastate.edu/catalog/livestock/dairy/dairy-freestall-housing-and-equipment

DairyCo - Agriculture and Horticulture Development Board (AHDB)

Dairy Housing a Best Practice Guide

www.dairyco.org.uk/resources-library/technical-information/buildings/dairy-housing-a-best-practice-guide/#.VMrQAaP29D8

DairyNZ

Dairy cow housing - A good practice guide for dairy housing in New Zealand

www.dairynz.co.nz/media/2240383/dairy-cow-housing-guide.pdf

Farmfact 8-4, Stand-off pads, Design and Construction

www.dairynz.co.nz/publications/farmfacts/farm-infrastructure/farmfact-8-4/

Farmfact 8-6, Covered Pads and Barns

www.dairynz.co.nz/publications/farmfacts/farm-infrastructure/farmfact-8-6/

IPENZ Practice Note 27 Dairy Farm Infrastructure, Version 1, September 2013

www.dairynz.co.nz/publications/environment/ipenz-practice-note-27-dairy-farm-infrastructure/

Stand-off Pads, your essential guide to planning, design and management

www.dairynz.co.nz/publications/farm/stand-off-pads/

Chapter 3

Services

1. Introduction

Providing all the required services for dairy cow housing is a critical step in design and construction. Time spent planning and designing can be wasted if all the required services are not sufficiently provided to meet the needs of the cows and the staff who will manage them.

Essential services include water, electrical and lighting.

2. Water

Regulatory minimum requirements relevant to water for cows are referenced in Table 2.1.

Table 2.1: Extract from Dairy Cattle Animal Welfare (Dairy Cattle) Code of Welfare 2010

| Minimum Standard No 5 - Water | |
|--------------------------------------|--|
| (a) | All dairy cattle must have access to a daily supply of drinking water sufficient for their needs and that is not harmful to their health |
| (b) | The water delivery system must be reliable and maintained to meet daily demand |
| (c) | In the event of a water delivery system failure, remedial action must be taken to ensure that daily water requirements are met. |

The quantity of water cows require depends on a number of factors including their size, activity, diet, lactation, production regime, and time of the season.

DairyNZ's *Dairy cow housing - A good practice guide for dairy housing in New Zealand (GPG)* should be referred to for further guidance around water provision (see Table 2.2 for relevant sections).

Table 2.2: DairyNZ- Dairy cow housing, Relevant Sections

| GPG Section Reference - Water requirements | |
|---|-----------------------------|
| 6.1 | Drinking water requirements |
| 6.2 | Locating water troughs |

Because of the potential complexity around providing sufficient water to cows at peak demand times, especially in larger dairy housing buildings, the distribution system is best planned by an experienced water system designer.

2.1 Water distribution

The water distribution system needs to be designed to meet the peak instantaneous needs, as well as the total daily needs of housed cows. The volume of water required will rise after feeding and milking, at dusk and during wash-down.

A minimum flow rate to each trough of 10 litres per minute is recommended but a potential flow rate of 20 litres per minute should be targeted as cows can drink at a rate of 15 to 20 litres per minute, and the trough needs to be refilled quickly for the next drinking cow.

Table 2.3: Water Troughs - Some Recommendations

- If the floor around the trough is not concrete then a concrete apron should be installed that extends 3–5m out from the trough
- Rectangular troughs should be used inside buildings rather than circular troughs that are usually placed in paddocks
- Keeping water levels at 10cm below the top of the trough reduces the amount of water spillage whilst cows are drinking
- Use float operated troughs to ensure an ongoing fresh supply of water is available
- Tipping troughs and static troughs with bungs or plugs should be used to ensure easy cleaning of the troughs. In addition the drained water can provide regular cleaning of effluent from cross passages.



Stainless steel tipping trough



Plastic static trough

2.2 Water storage

Intermediate water tanks will likely be required if the water source is incapable of delivering the required peak flow rate. Intermediate tanks, usually closed plastic or concrete, also protect the water from external contamination.

Presuming the water source is reliable and able to deliver the required flow rate for the majority of the time, the intermediate water storage should be sized for a minimum of two hours of peak flow.

Intermediate storage systems options include:

- **Two pump**
Pump from source and then pump from intermediate storage. The pump from source needs a lower level cut-off and a capacity slightly less than the water source's production level to prevent pumping the source dry. The pump from intermediate storage needs to be sized to provide the peak use flow rate.
- **One pump and raised tank**
Pump from source to a raised tank which gravity feeds the intermediate tank as required. Unlike a pump, gravity does not break down so supply is more secure. However, the lower gravity pressure may require the use of larger pipes and makeup valves.

If the water source supply is unreliable then the required intermediate storage volume should be sufficient for at least one-day's total water usage. Where water pressure is low, booster pumps or extra covered storage tanks will need to be considered.

Table 2.4: Water Storage - Good Practice Points

- Storage should be positioned for easy cleaning and inspection
- Should be covered to ensure dust, vermin, birds and other contaminants are restricted
- Inlet pipes should be at least one pipe diameter higher than the overflow
- All water for animal housing needs to come through tank supply rather than directly from source, such as a stream
- In regions vulnerable to frost, the water supply and containment should be adequately protected with insulation or heat tape so that water flow will not become restricted.

2.3 Pipework

The type of pipe material selected needs to be fit for its purpose. Metal pipe and fittings can corrode whereas polyvinyl chloride (PVC) or polyethylene (PE) pipe with nylon fittings and stainless steel fasteners are less susceptible to corrosion and freezing related issues. Manufacturer's recommendations should always be adopted, especially around installation, temperature range, and pressure rating limits.

Exposed overhead pipes pose a greater risk of accidental impact damage, so need to be adequately protected from this risk if used. Pipes above ground may also require additional measures to prevent freezing.

2.3.1 Freezing protection

Where freezing is a risk, water pipe placement options include:

- **Overhead**
Larger dairy housing buildings with high ceilings provide scope for placement sufficiently high and clear of possible impact damage from moving machinery. Overhead pipe lines can be conveniently dropped down to troughs. However, pipes will need to be frost insulated and protected from animal damage.
- **Below ground**
A better choice for freezing prevention might be burying pipes with larger diameters below ground. However, pressure testing of under floor pipes should always be completed prior to placement of concrete floors. How buried pipes will be accessed should a leak occur, or when undertaking alteration for new connections, needs to be considered before construction. Where buried pipes emerge from the floor at troughs or at hose connection points can be vulnerable locations, especially for plastic pipes and additional protection should be provided to the pipes at these positions.

It is good practice to separate water used for stock drinking from water used for cleaning down dairy plant and floors. Separating the reticulation will minimise the risk of water source contamination. Splitting the water source into two separate supply lines, each with backflow prevention devices at strategic points, will prevent any contamination at the hose or trough from travelling back up the pipework to the source(s).

A typical backflow prevention device, also known as a Reduced Pressure Zone (RPZ) valve, is shown in Figure 2.1 and typically consists of two non-return valves with a vacuum break between them.

Figure 2.1: Backflow Prevention Device

2.4 Water for cleaning

Best positioning of water outlet locations needs to be considered when the floor layout is being developed, not post-construction. Quick hose access, for example using “camlock” fittings, is recommended adjacent to every water trough in the cross over. Having a hose at every trough is preferable to using long hoses that require some manual effort to move, are prone to kinks and tangles, and which increase trip hazards. Hose outlets must be robustly anchored so that the pipework is not strained by pulling on the hose.

2.5 Water for humidity/temperature control

In regions subject to high temperatures, a cow wetting sprinkler system may be required and the demand for water to supply this system needs to be allowed for.

Further information about humidity and temperature control is contained in the “Environmental Control” chapter.

3. Electrical

3.1 Introduction

Because of the specialist knowledge, and skills required, especially for larger dairy housing facilities, the content of this section is intended to provide only general guidance. The installation of electrical systems is best left to experienced electrical tradespeople working under the instruction of electrical professionals, who would also complete the design to relevant New Zealand codes of practice and provide any signoff required.

A building owner would normally engage an electrical contractor to complete the design and installation. Depending on the complexity and specialist skills required, they would in turn engage others to undertake certain aspects of the work and so meet both project specific and regulatory requirements.

Table 3.1 lists parties that should be consulted.

Table 3.1: Electrical Consultation

| Electrical consultation required with: |
|---|
| <ul style="list-style-type: none"> • The building owner/farmer to understand what their requirements and expectations are • Local power supplier to confirm required peak power demand is available to be delivered to the site. (Note: Some sites may not have 3-phase power available.) • Licensed electrician who has previously worked with dairy equipment and supplies, to help plan and install distribution panels and motor circuits, select conductors and fixtures, and verify compliance with relevant regulations • Electrical equipment suppliers about dust and moisture-tight fixtures and wiring required for damp and wet buildings. Plan ahead because some of this equipment may have to be pre-ordered through electrical wholesalers • Suppliers who can list voltage and current needs of equipment to be installed • Insurance companies to determine any insurance coverage requirements • Local building officials where applicable regarding regulatory compliance. |

3.2 Electrical general comments

Attention should be given to the protection of all electrical wiring and equipment against the ingress of moisture, dust and corrosive gases. Wires should be positioned and protected to prevent unintended damage from cows and farm staff. The threat of rodent damage should be kept in mind when selecting cables and deciding on their location. Particular attention should be given to the “earth bonding” of all metalwork in livestock buildings, including structural steel and concrete reinforcing steel, since most farm animals will react to voltages too low for humans to notice. Fail-safe and back-up systems should be provided in the event of power failure.

Wherever possible, provide electrical services through a single service entrance panel with enough circuit breakers to meet present needs and some future expansion. If multiple service entrance and distribution panels are required, install a separate main disconnecting switch ahead of the multiple panels. Then wire each distribution panel as a subpanel from the main disconnects.

3.2.1 Stray voltages

Step potentials are the voltage differences that occur due to electrical current passing through the floor, and the resistance to this flow of current caused by humans and animals standing on it, as shown in Figure 3.1.

Touch potentials are the voltage differences that occur between the feet of humans and animals and other surfaces they may touch, for example railings. These are due to the same cause.

Step and touch potentials are also known as; stray residual currents, stray loads or stray voltages.

Stray voltage, often caused by damaged grounding devices, can intensify the neutral-to-earth voltage connection, through faulty wiring and electrical equipment, or by improper grounding. A major contributor is faulty installation of high frequency power electronic devices such as variable speed drives and switch-mode power supplies.

While it is unlikely that stray voltages will be felt by humans, they may cause discomfort to cows. It is recognised that stray voltages as low as two volts may cause cows to be reluctant to enter buildings and cause discomfort and nervousness that adversely affects milk production.

The Standards New Zealand Handbook, Electrical installations in dairy sheds, discusses supply and earthing systems for dairy sheds, 6117:2014 SNZ HB promotes the use of the “TT earthing system” in which the supply is earthed and the exposed conductive parts of the installation are connected to earth electrodes electrically independent of the earth electrode of the supply system.

Figure 3.1: Cow Step Potential

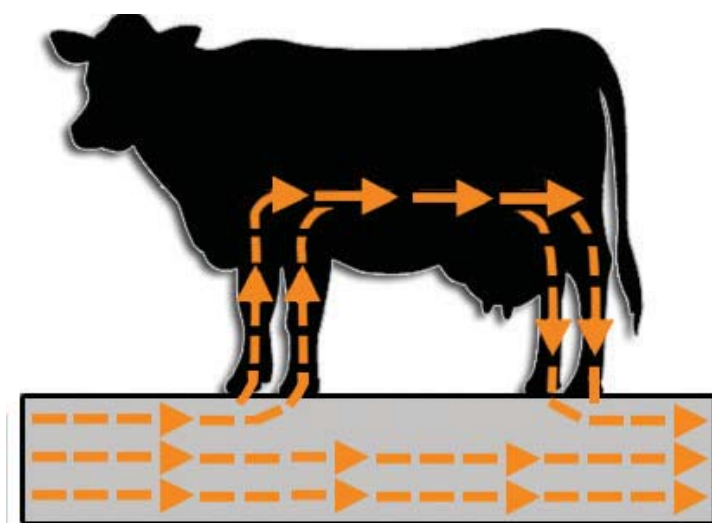

4. Lighting

The levels of illumination both from natural and artificial sources must provide sufficient light to allow farm staff to safely undertake stock movement and any husbandry activities, in addition to operational tasks such as feeding out.

Table 4.1: Extract from *Dairy Cattle Animal Welfare (Dairy Cattle) Code of Welfare 2010*, page 18

| Recommended Best Practice |
|---|
| (d) Lighting that is sufficient to enable inspection of all animals kept indoors (20–50 lux) should be available but should not be so intense as to cause discomfort to the animals. (As a guide, 50 lux is sufficient light to read a newspaper at arm's length.) |

Lighting for farm staff should include illuminating any exterior pathways and hazards such as sumps and drain channels as these could be dangerous if a cover is removed. Any breakdown maintenance areas such as at the switchboard, pumps, and scraper drive units, should also be illuminated at night. While portable lighting (such as torches and vehicle lamps) may be used in lieu of this lighting, it is not recommended as it is less reliable and provides less illumination than dedicated fixed lighting.

4.1 Properties of light

Some important properties of light are observable and measurable and need to be considered when a lighting system is being designed and installed.

4.1.1 Lighting level

The lighting level is measured in lux. Lux is a unit of light measurement which takes into account the area light falls on and so is a measure of light intensity. An increase in lux is related to the square of the area. It is therefore not a linear scale so a doubled lux level does not appear as twice as bright.

4.1.2 Lighting colour rendering

The degree to which light from different sources accurately renders colour is known as the colour rendering index (Ra) with a maximum level of Ra 100. Best rendering is from natural daylight and tungsten light. At the other end of the scale is low pressure sodium light (the yellow light often used for street lighting) which has an index of just Ra 20. Colour rendering is important when it is necessary to discern one colour from the next – for veterinary tasks, for instance.

Table 4.2 shows different Ra values for different lamp types.

Table 4.2: Colour Rendering Index (Ra) Value for Common Lights

| Lamp Type | Colour Rendition Index |
|---------------------------------|------------------------|
| Incandescent | 100 |
| Halogen | 100 |
| Fluorescent | 70-95 |
| High Intensity discharge | |
| Mercury vapour | 20-60 |
| Metal halide | 60-80 |
| High pressure sodium | 40-60 |

4.1.3 Uniformity

Uniformity should be considered. To provide the best light uniformity it is better to have a larger number of small lamps rather than use fewer large ones.

4.1.4 Shadows

Shadows are not desirable for visually critical tasks. Shadows are most defined when light sources are small, like a tungsten halogen lamp, and where a small number of high-powered lamps are used. Shadows can be minimised by using lights with a large emitting area – such as long fluorescent lights and by using a larger number of smaller wattage lights.

The performance of a lighting system is often a compromise between the installation of a large array of the most desirable lights, and cost. Fewer but larger lights tend to cost less to install, both in terms of wiring and capital cost, but uniformity will be poorer and there will be more shadows. Different locations require different lighting solutions and Table 4.3 provides some guidance on this.

Table 4.3: Lighting Applications

| Application | Lux level required | Colour rendering | Uniformity | Control | Comments |
|----------------------|--------------------------|------------------|------------|--|--|
| Feeding area | 50 lux for general | Low to medium | Medium | Timed with light level sensing. Fluorescents can use light level driven dimming | High pressure sodium, metal halide lights or multiple fluorescent fittings |
| Stall (bedding) area | 160 to 200 lux | Low to medium | Medium | | Multiple fluorescent fittings |
| Milking shed | 500 lux for working area | Good | Very good | Timed with manual override | Fluorescent lights will punch light through the mass of pipes and fittings and give more light with less shadows |
| Milking shed yard | 50 lux | Low to medium | Medium | Timed with manual override | High pressure sodium or metal halide lights |

| Application | Lux level required | Colour rendering | Uniformity | Control | Comments |
|-------------------------|--------------------|------------------|------------|-------------------|--|
| Milking equipment areas | 200 lux | Good | Medium | Proximity | Fluorescent lights are most commonly used |
| Outside areas | 20 lux | Low to medium | Low | Timed/light level | High pressure sodium or metal halide lights are the best compromise between cost and performance |
| Office | 300 to 500 lux | Good | Good | Proximity | Fluorescent lights are most commonly used |

4.2 Provision of light

4.2.1 Natural lighting

Natural lighting is typically the sole source of daytime lighting for the interior of buildings. Ten to fifteen percent roof light area, or the equivalent from open walls and vents, will be enough to provide between 100 and 500 lux through natural lighting, depending on the time of day and year.

Some dairy housing suppliers suggest that lighting effectiveness may be enhanced by reflective interior building surfaces, reducing the need for excessive sky lighting, which can be a source of heat and glare, and softening the effect of “stripes” of contrasting light and shadow.

Some structures will have an area ratio of 4:1 or even up to 2:1 of galvanised iron to clear skylight. If using transparent sheeting to admit light, it is important to maintain the cleanliness of the sheets to sustain the performance.

However, naturally lit buildings need to be well ventilated to counteract the effects of heat build-up from solar gain through skylights and the proportion of roof lights fitted may need to be higher on south facing roofs than north facing.

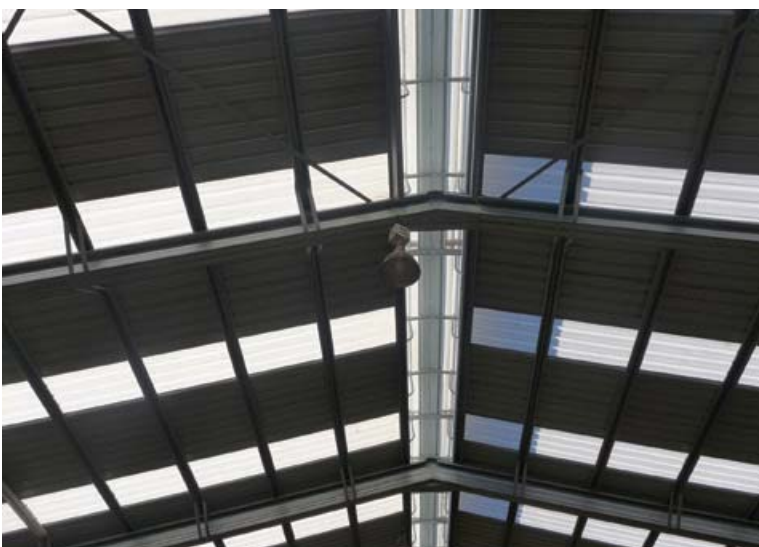



Roof lighting

4.3 Types of lighting

There is a wide range of lighting systems to provide artificial light and each type has its own unique set of characteristics as detailed in Table 4.4. These include capital cost, efficiency, longevity, colour appearance, colour temperature, shadow potential, and start up time. Lamps should be selected based on factors such as, light output, initial and operating costs, energy efficiency, and maintenance. All lighting fixtures must be watertight and appropriately mounted (see Table 4.5).

Table 4.4: Common Lighting Types Comparison

| Types | Energy Efficiency | Lighting Options | Best use in Dairy Housing Systems |
|---|-------------------|--|--|
| Incandescent Types | | | |
| Incandescent (traditional light bulbs) | Poor | Best where lighting is only required for brief periods, where turned on/off frequently. Cheap, easy to replace and instantaneous, energy inefficient, short life span. Output greatly affected by dust and should be cleaned annually | Not likely to be used for any part of animal housing other than staff quarters or toilets. |
| Halogen | Poor | To provide high intensity light in a specific direction, for example in walkways. Cheap but expensive to operate because of low energy efficiency. | For lighting up outside areas such as concrete lane ways between barns and milking or any external entrance areas into facilities. Useful where high light levels required for short periods. Suitable for security type lights. |
| <div style="display: flex; justify-content: space-around; align-items: center;"> <div style="text-align: center;">  <p>Incandescent</p> </div> <div style="text-align: center;">  <p>Halogen</p> </div> </div> | | | |
| Discharge Types | | | |
| Fluorescent | Moderate | Cost effective for general lighting. Most effective when mounted below a height of 3.5m. Life span 4-5 years provided tubes are cleaned annually. Same light output at a lower wattage than incandescent and uses up to 66% less energy. | General purpose lighting. |
| Mercury vapour (high pressure) | Moderate | High light output suitable for general lighting in larger areas with high roofs, gives off a slightly bluish light. Fairly inexpensive and the lamps have a long life. Takes several minutes to reach full brightness after switched on. | Not recommended for use in dairy facilities as mercury in burned out lights is an environmental hazard. Less energy efficient and output decreases with time. |

| Types | Energy Efficiency | Lighting Options | Best use in Dairy Housing Systems |
|---|-------------------|--|---|
| Metal Halide | Good | Similar to Mercury Vapour in uses and operation but have a shorter life (12,000+ hours) and are 3-4 times more expensive. Throws a very white light. | General purpose for lighting up the inside of farm buildings. |
| High pressure sodium | Excellent | Excellent energy efficiency and have a long life (25,000 hours). Best suited to outdoor flood lighting | |
|  <p style="text-align: center;"> Mercury Vapour Metal Halide High Pressure Sodium </p> | | | |
| Solid State Type | | | |
| Light Emitting Diode (LED) | Excellent | Very energy efficient, provide much more light for less wattage. Very long life (50,000+ hours). Expensive but price is falling. Less frequent replacement required. | Most situations |
|  <p style="text-align: center;">LED</p> | | | |

Table 4.5: Light Mounting

Light mounting considerations:

- Mounting height and separation distance has an impact on average illumination levels and uniformity, and excessively high mounting wastes light by dispersing it over too large an area
- Locate and mount lights to avoid shadows
- It should be possible to mount most light fittings directly on trusses or suspended on a sturdy chain using a hook, cord, and plug (HCP). HCP mountings are frequently used as they allow height adjustment to improve light distribution and uniformity.
- Additional lighting may be considered at watering troughs with minimum lighting available at night to encourage drinking.

4.4 Lighting control

Automation of lighting will save energy costs. Lighting can be automated in one or more ways:

- **Movement sensors** include passive infrared (PIR), ultrasonic and microwave. PIRs are the most common and cheapest sensor, although they are quite coarse in operation. At the other extreme, microwaves are very sensitive, but will react to the slightest movement. Some of the best control systems use PIRs to switch lights on and a microwave sensor to maintain the “on” state.
- **Timers** can either be time switches or delay switches. Time switches are usually for 24 hour, or 24 hour/7 day cycles.
- **Delay switches** switch off lights after a pre-set time. Used for areas of temporary occupation, for example walkways or toilets where lights are only required for a short amount of time.
- **Ambient light sensors** switch on and off as ambient light levels cross a particular value. This is a common method used to trigger cow barn lights, in conjunction with a clock controller.

4.5 Lighting system design

Some other points to consider in lighting design are listed in Table 4.6.

Table 4.6: Lighting System Design

- Some lights have a high capital cost but this may be offset by a low operation and maintenance cost
- How the lighting is used on a daily basis will determine the appropriate places for switches
- Grouping and switching the lights in banks may provide different lighting levels
- Lights should be positioned to allow for easy cleaning and safe bulb changing
- Where access is difficult, use low maintenance type lights
- Consider reflectivity of roofs and walls. Colouring surfaces white or a light colour can increase the lighting level dramatically
- In most cases, fittings need to be water and dustproof. Make sure the ones you choose are up to standard.

References

DairyCo

(DairyCo is a division of the Agriculture and Horticulture Development Board, UK

Dairy Housing – A Best Practice Guide, 2012

www.dairyco.org.uk/resources-library/technical-information/buildings/dairy-housing-a-best-practice-guide/#.VKnxdaP29D8

DairyNZ

Stand-off Pads: Your Essential Guide to Planning, Design and Management

www.dairynz.co.nz/media/667797/dairynz_stand_off_pads_booklet.pdf

Ontario Ministry of Agriculture, Food and Rural Affairs

Dairy Cattle – Stray Voltage Problems in Livestock Production

www.omafra.gov.on.ca/english/livestock/dairy/facts/strayvol.htm

Standards New Zealand

New Zealand Handbook – Electrical Installations in Dairy Sheds, SNZ HB 6117:2014

www.standards.co.nz/touchstone/energy/2014/mar/electrical-installations-in-dairy-sheds-new-handbook/

Chapter 4
Ventilation

1. Introduction

Designers of dairy housing must consider the air environment inside the facility from the perspective of the cow. Well considered air environmental control system design will assist in maximising cow comfort, health and welfare which optimise production. This includes effective ventilation design.

Essentially a good set of environment conditions will be achieved with systems in place that can:

- Regularly exchange air
- Maintain a uniform environment
- Be reliable regardless of external environmental conditions
- Be economic all year round.

This can be problematic due to often competing expectations for cow comfort, effective floor layout, low maintenance building structure, construction ease, operational efficiency, and not least of all, good economic return. Providing adequate air environmental control is often overlooked in dairy housing building design, and retrofitting suitable systems to an existing building can be expensive.

The essential priorities for environment control which must be considered when designing these buildings includes:

- Removing excess heat
- Providing correct air speed for stock
- Limiting direct solar thermal and ultraviolet (UV) radiation onto animals
- Removing excess water vapour
- Providing a uniform distribution of air
- Minimising waste gas levels
- Removing micro-organisms, dust and gases.

**Extract from *Dairy Cattle Animal Welfare (Dairy Cattle) Code of Welfare 2010, Minimum Standard No. 9*
- Housing Cows and Calves**

(c) Ventilation must also be sufficient to prevent a build-up of harmful concentrations of gases such as ammonia and carbon dioxide.

(d) If ammonia levels of 25ppm or more are detected within the housing, immediate action must be taken to reduce ammonia levels

The conditions cows experience in a housing facility will be affected by the natural ambient conditions at the farm location. In addition, roofs and walls affect prevailing wind flow, the level of shading and rainfall, and act as thermal barriers. The resulting temperature, humidity and solar (including thermal and UV) radiation conditions that occur under a roof are not always going to be optimal and in fact can lead to cow stress. Depending on external conditions, these stress conditions can become frequent to the extent that active ventilation management is necessary.

This chapter offers, from an engineering perspective, “how” air environmental control systems can be incorporated into a building structure, whereas the *DairyNZ Dairy cow housing - A good practice guide for dairy housing in New Zealand* covers aspects of “why” air environmental control must be considered and incorporated.

Designers should not rely solely on recommendations made in this practice note, but should independently undertake their own assessment of environmental control requirements for the facility they are involved in. Any assessment must include factors such as site, location, climate, herd size and operations.



Low speed fans above feeding passageway

2. Environmental Parameters and Cow Comfort

Through research, it has been established that dairy cows perform best within certain environmental conditions. A matrix of temperature, humidity, air speed and shading (as shown in Table 2.1) needs to be considered as the animals react differently according to the combination of conditions, not just the individual parameter.

Table 2.1: Cow Comfort Ranges for Different Environmental Parameters

| Parameter | Lower | Upper |
|-----------------|--------------------|------------------------------|
| Temperature | -15°C | +25°C |
| Humidity | | < 75% Relative Humidity (RH) |
| Air speed | 2 metres/sec (m/s) | 5 metres/sec (m/s) |
| Solar Radiation | | < full summer sun |

Note: The Temperature Humidity Index (THI), referenced in many research papers, only acknowledges that the combination of two critical parameters needs to be considered, that is, temperature and humidity. However, the THI does not reflect the compounding impact of air movement and solar (thermal and UV) radiation that may exacerbate the stress levels on animals.

While cool temperatures may not be comfortable to humans, dairy cows are likely to prefer them. Further, while cows perform very well over a range of temperatures, a critical comfort factor for them is also having a clean and dry environment with plenty of “fresh” air movement across them with limited direct radiation onto their bodies.

2.1 Temperature and humidity index

Temperature and humidity comfort levels are the most apparent in studied conditions and often are seen as the only ones to monitor and manage.

Their relationship can be presented in Table 2.2.

Table 2.2: Temperature - Humidity Index Values

(Adapted from "Heat Stress Climatic Conditions and the Physiological Responses of Cattle", Fifth International Dairy Housing Proceedings, 2003)

| | | Relative Humidity, % | | | | | | | | | | | | | | | | | | | |
|-----------------|----|----------------------|----|----|----|----|----|----|----|----|----|----|----|----|----|----|----|-----|-----|-----|-----|
| | | 5 | 10 | 15 | 20 | 25 | 30 | 35 | 40 | 45 | 50 | 55 | 60 | 65 | 70 | 75 | 80 | 85 | 90 | 95 | 100 |
| Temperature, °C | 20 | 63 | 63 | 63 | 64 | 64 | 64 | 64 | 65 | 65 | 65 | 66 | 66 | 66 | 66 | 67 | 67 | 67 | 67 | 68 | 68 |
| | 22 | 64 | 65 | 65 | 66 | 66 | 66 | 67 | 67 | 67 | 68 | 68 | 69 | 69 | 69 | 70 | 70 | 70 | 71 | 71 | 72 |
| | 24 | 66 | 67 | 67 | 68 | 68 | 69 | 69 | 70 | 70 | 70 | 71 | 71 | 72 | 72 | 73 | 73 | 74 | 74 | 75 | 75 |
| | 26 | 68 | 69 | 69 | 70 | 70 | 71 | 71 | 72 | 73 | 73 | 74 | 74 | 75 | 75 | 76 | 77 | 77 | 78 | 78 | 79 |
| | 28 | 70 | 70 | 71 | 72 | 72 | 73 | 74 | 74 | 75 | 76 | 76 | 77 | 78 | 78 | 79 | 80 | 80 | 81 | 82 | 82 |
| | 30 | 71 | 72 | 73 | 74 | 74 | 75 | 76 | 77 | 78 | 78 | 79 | 80 | 81 | 81 | 81 | 82 | 83 | 84 | 85 | 86 |
| | 32 | 73 | 74 | 75 | 76 | 77 | 77 | 78 | 79 | 80 | 81 | 82 | 83 | 84 | 84 | 85 | 86 | 87 | 88 | 89 | 90 |
| | 34 | 75 | 76 | 77 | 78 | 79 | 80 | 81 | 82 | 83 | 84 | 84 | 85 | 86 | 87 | 88 | 89 | 90 | 91 | 92 | 93 |
| | 36 | 77 | 78 | 79 | 80 | 81 | 82 | 83 | 84 | 85 | 86 | 87 | 88 | 89 | 90 | 91 | 93 | 94 | 95 | 96 | 97 |
| | 38 | 78 | 79 | 81 | 82 | 83 | 84 | 85 | 86 | 88 | 89 | 90 | 91 | 92 | 93 | 95 | 96 | 97 | 98 | 99 | 100 |
| | 40 | 80 | 81 | 82 | 84 | 85 | 86 | 88 | 89 | 90 | 91 | 93 | 94 | 95 | 96 | 98 | 99 | 100 | 101 | 103 | 104 |

| | | | | |
|-----------|-------------|------------|---------------|-------------------|
| no stress | mild stress | distressed | severe stress | potentially fatal |
|-----------|-------------|------------|---------------|-------------------|

However, in the context of typical New Zealand ambient conditions at many New Zealand dairy locations, even usual outside conditions can border on being mildly stressful for cows.

When cows are in an enclosed or semi-enclosed building into which external air is brought, temperature and humidity will rise above ambient. Temperatures can rapidly rise and stagnant humid conditions develop within a poorly controlled facility, leading to stock rapidly entering the "distressed" zone.

The above diagram, often reproduced in industry material, does not take into account air movement and radiation of thermal energy from the sun directly or indirectly reradiated off hot surfaces. Low air speed and high radiation can produce stress conditions even when the THI indicates no or low stress conditions.

Therefore a combination of environment parameters must be considered simultaneously.

3. Air Environmental Control Principles

3.1 Basic principles

Good environment control is a process that accomplishes the following outcomes:

- Brings external air into the building through planned openings
- Thoroughly mixes incoming and inside air
- Picks up and transfers heat, moisture, and air contaminants
- Exhausts warm, moist, contaminated air from the building.

The installation of one or more systems may be required to deliver the required outcomes. However, before such systems are incorporated into a facility it is important to understand some key principles.

As a starting point, Figure 3.1 provides a basic overview of the environmental management concept.

Figure 3.1: Basic Environmental Management Concept

(Adapted from *Dairy Freestall Housing and Equipment*, MWPS-7 Eighth Edition (2013), figure 7-1 Principles of Air)

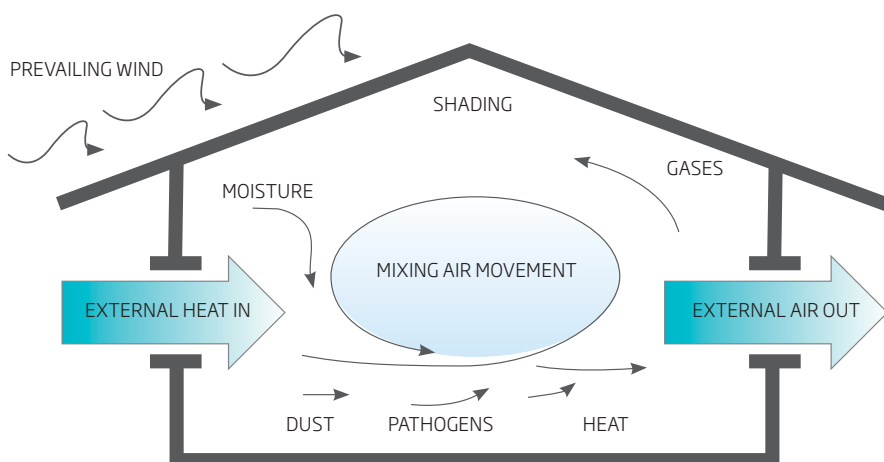

3.2 Psychrometric principles of air

When designing an environmental management system it is crucial to understand the basic psychrometric principles of air.

Assuming external air is cooler than internal air, designing a ventilation system that moves air into and then out of a structure will generally provide a cooling effect by mixing the air streams. Therefore by inference, cooling with air exchange is only as good as the incoming cooling air. In some ambient air conditions where temperature is high, especially in the peak of summer, this may be insufficient and additional cooling may be required.

A cautionary note is needed. A cooling system that relies solely on high rates of air exchange will affect the humidity within the structure as shown in Figure 3.2. High volumes of external air brought in will heat up the inside of a building which increases its water holding capacity. The amount of water vapour removed from the structure when the warm moist air is exhausted may drop the humidity to a low level. The result may be a significant increase in drinking water demand by the animals to counteract the dehydration effect.

Figure 3.2: Possible Effects of High Air Exchange Rate

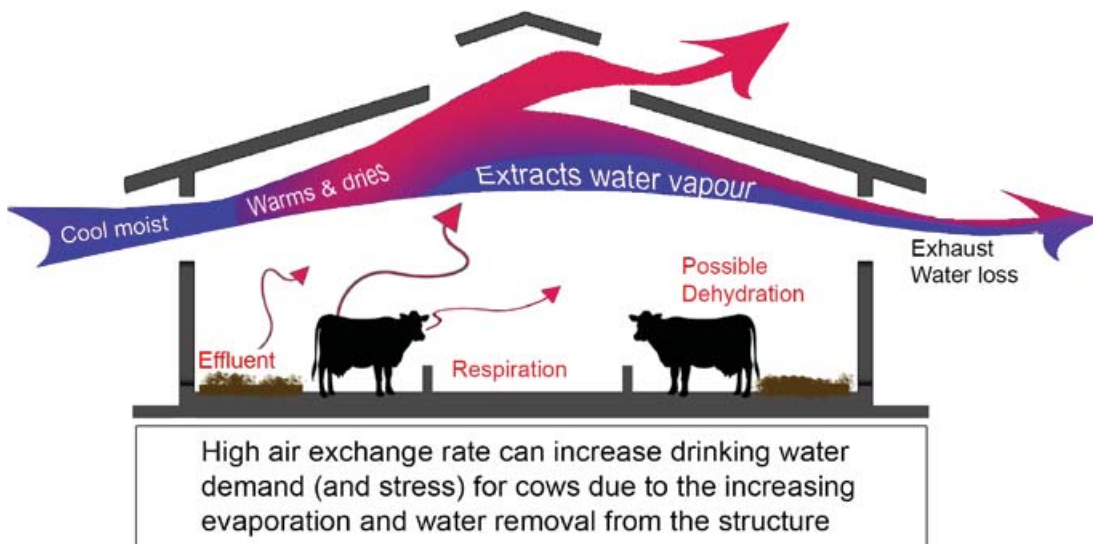

An additional consideration is the impact a ventilation system has on air speed within the structure. Dairy cows prefer an air speed of around two to five metres per second (7 to 18 kilometres per hour). This is equivalent to Level 2 to Level 3 on the Beaufort scale and is described as “light to gentle breeze” where “wind is felt on exposed skin, leaves rustle and wind vanes begin to move” up to a point where “leaves and small twigs are constantly moving, light flags extended”. Therefore, being able to provide this optimum air movement across cows consistently, and under any external wind condition is an important consideration in passive or “natural” ventilation systems.

3.3 Principles of heat and shade control

3.3.1 Heat

The latent heat of evaporation of water is much higher than the specific heat capacity of air. Therefore only a small amount of water vaporised into the atmosphere is required compared to the large volume of air to absorb the same amount of heat, as illustrated in Figure 3.3. Once evaporated, only a small amount of air needs to be exchanged to the outside to take the water vapour laden air and hence take heat out of the structure.

Figure 3.3: Cooling Effect of Water Verses Air

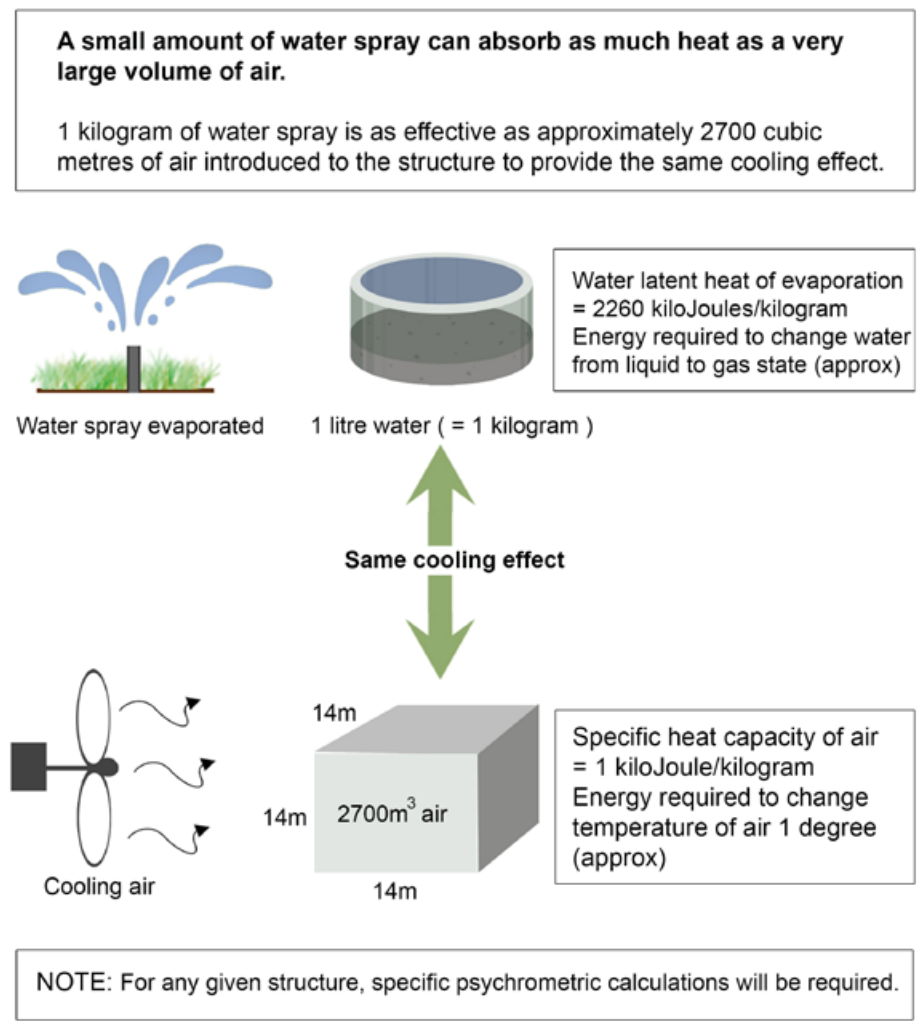

A water based cooling system also gives the ability to manage low humidity situations that may occur on summer days when hot dry external air enters a structure and heats through mixing. It further lowers the humidity to the point where dehydration stress and increased dust, can become a risk where air exchange is insufficient.

If heat is removed using evaporative cooling, and air exchange rate is adjusted down until it is just sufficient to remove the water, then the facility may require a separate method to establish consistent air movement and speeds across the housed cows. Low and high-speed fans and air ducts can be used to supplement air movement.

3.3.2 Shade

Solid roof structures are opaque to visible solar light. However, a hot roof surface that has absorbed solar energy (short waves) will often produce long wave infrared re-radiation, a “heating” energy that will be just as stressful to the animals. Surface coatings that are designed with the effects of reflectance and emissivity in mind can be used to manage thermal re-radiation. In most situations, a highly reflective outer surface (for example, light coloured steel) and light coloured inner surfaces will achieve the most stable temperature conditions. Highly reflective lining materials may provide additional thermal insulation under extreme cold ambient environments but care is needed to ensure the animals own heat is not reflect back onto them unnecessarily under high heat conditions.

3.3.2.1 SHADE FOR PLASTIC ROOF SYSTEMS

If using plastic roof systems adapted from the greenhouse industry, designers will need to consider how to provide adequate shading as full summer solar radiation is undesirable. Cattle in natural situations avoid full sun and seek shade when available. Solar radiation produces stress to cows from direct exposure of UV to the animal’s skin and the heating effect of infrared.

A plastic covering formulation needs to be selected that reduces the effects of both UV and infrared transmission as well as providing the required structural strength against wind loads and durability. Natural polyethylene (PE) degrades rapidly and provides little electro-magnetic spectrum management. Most modern plastic roof covering materials have taken into account the possibilities of plastic component formulations or utilise a co-extrusion process to provide the necessary attributes through a combination of layers.

An alternative is to install a secondary shading layer which provides reduced solar radiation but also acts as a thermal barrier. It is unlikely that too much shading would be an issue when using plastics roofing over animals. However, care must be taken in choosing a shading system that does not negatively affect the airflow patterns that are crucial to the ventilation of the structure. The costs of mitigating the undesirable elements of a plastics roof may completely offset savings in a perceived “cheaper” roof system.

Plastic roof covering options are further discussed in Section 8 of the “Building Structure” chapter.

Figure 3.4 illustrates how different roof materials affect the different levels of ultra violet, visible and thermal radiation reaching animals in enclosed structures.

Figure 3.4: Effects of Different Roof Materials

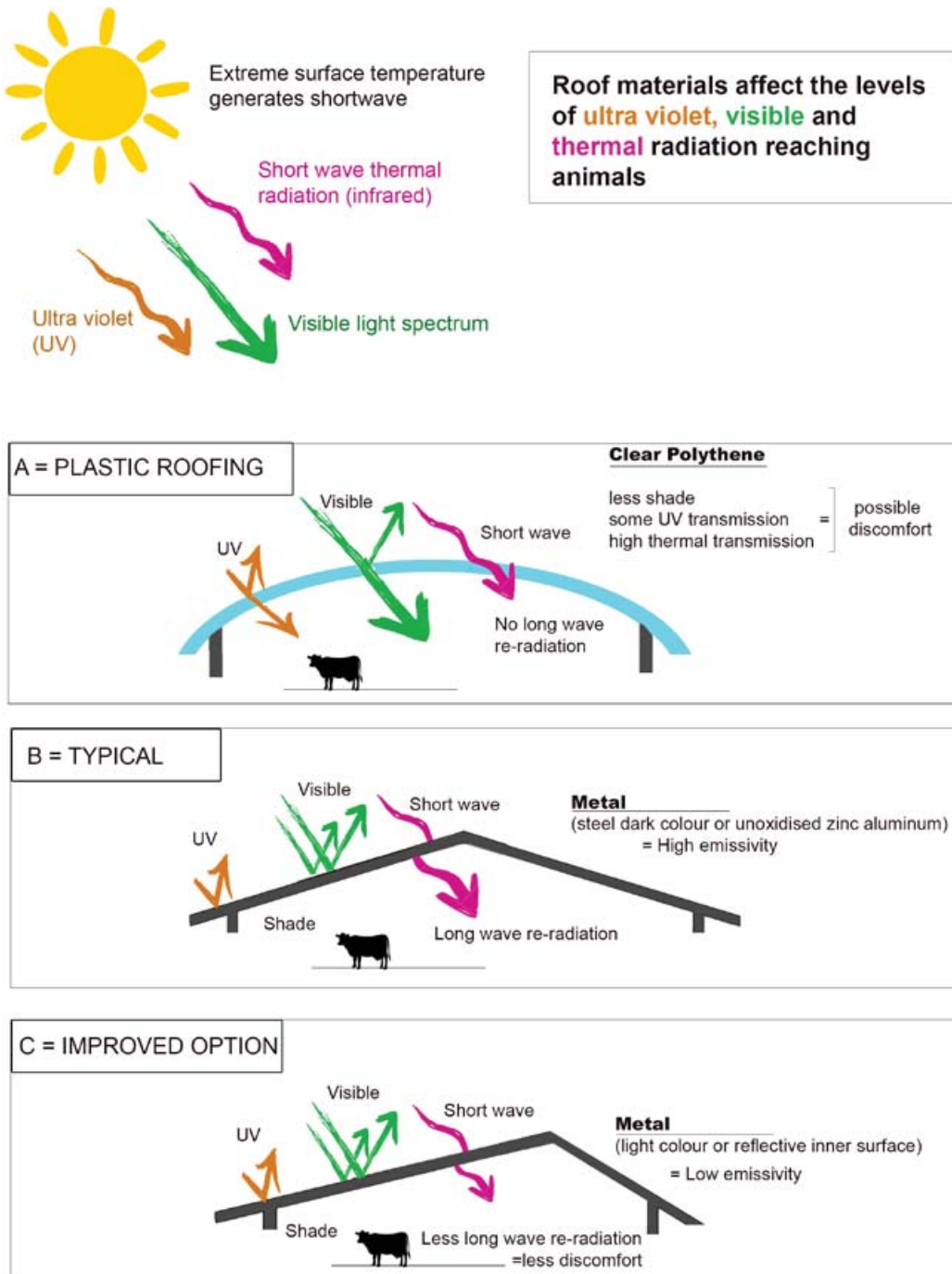

4. Ventilation Systems

4.1 Ventilation key parameters

Research highlights three key parameters upon which good hot-weather (typical summer high temperature of 24°C) ventilation control depends:

RATE OF AIR EXCHANGE

While systems for delivering high rates of air exchange naturally or mechanically are available, there is evidence that elevating the rate of air exchange alone is limited in its ability to improve the microclimate at cow level in modern production-scale barns.

AIR DISTRIBUTION

Air distribution and hence uniformity of climate conditions is not generally problematic inside cow housing structures, but may be an issue for certain building sites and layouts where prevailing winds can cause high gradients within a structure. Primary “passive” ventilation systems are designed for given sets of conditions, and small deviations from these conditions usually give rise to concerns about air distribution.

AIR VELOCITY AT COW LEVEL

Enhanced air speeds at cow level are needed in dairy buildings, beyond that required for attainment of desired air exchange and distribution. System design for summertime conditions should target improved air velocity at animal level. This will enhance animal performance associated with increasing the amount of evaporative cooling that occurs within the immediate vicinity of the cows.

4.2 Natural versus mechanical ventilation

4.2.1 Natural ventilation

Natural, also known as passive, ventilation relies fundamentally on wind, principles of thermal buoyancy of air heated by the animals themselves, and, to a lesser extent, on the temperature differential between outside and inside air, to move air through the building. Natural ventilation may not be achievable or sufficiently reliable in certain climate locations or with certain building configurations.

The energy needed to achieve active air exchange rates is significant. Even slight air pressure changes caused within a structure by external wind hitting and penetrating a side wall opening can overpower and “stall” the low energy generated by buoyancy effects. In other words, buoyancy, due to the low energy it generates, is not as “strong” as an external driving force.

Natural ventilation systems are generally lower in both capital and operational cost. The trade-off is they are likely to be less efficient across a range of external ambient conditions and therefore less reliable in meeting the required animal comfort levels. The farmer must decide what trade-off between lower cost and lower performance they are willing to accept.

Experience shows that although New Zealand’s temperate climate and wind patterns allow natural ventilation to be incorporated into building design, in some districts, the inconsistency of local weather patterns can lead to an unacceptable number to periods when cow comfort reaches stress levels. For example, it is common to have high

temperatures associated with near still ambient conditions. This means that passive ventilation systems may not provide either air exchange or more importantly air movement to the required standards. This can be more apparent as structures get longer and wider, or are built with multiple roof bays linked side by side.



Open sided structure (Note: internal fans)

4.2.2 Mechanical ventilation

Mechanical, also known as forced or active, ventilation offers control of the facilities ventilation system by mechanical means independent of external or internal conditions.

Mechanical ventilation is widely incorporated into dairy buildings in Europe and North America, largely because of the performance standard required and level of reliability necessary for consistent production. In many of these dairy production areas, the climate conditions can be more extreme than in New Zealand, especially with respect to much higher and much lower temperatures. Active systems provide continuous performance even under these extremes.

By comparison, New Zealand's climate is less extreme but still provides variability across seasons, and within seasons. Further, climate is variable ranging from colder and damper conditions in Southland through to more tropical conditions of Northland. To date the dairy industry has accepted a lower reliability of mechanical ventilation system and has tended towards lower capital cost passive ventilation systems. There are very few mechanically ventilated dairy housing structures in New Zealand. If productivity demands and animal comfort requirements increase, it is likely more focus will be given to reliability of ventilation systems and some buildings will not be able to rely on passive ventilation only.

Due to the complexity of ventilation design with respect to psychrometric principles, this practice note only examines passive and active mechanical ventilation in principle. For detailed design of either passive or active ventilation, it is recommended a full air environmental control system design that considers ambient conditions be undertaken. It is further recommended that specialist advice be sought for the design of mechanical ventilation systems, rather than ordering a unit "off the shelf" from a supplier.

The design of a successful ventilation system can be complex and requires consideration of the:

- Span, length and roof configuration of the building
- Location and orientation of the building relative to prevailing winds and other buildings
- Topography, as this affects air drainage and wind swirl patterns
- Windbreaks
- Stocking rate (number of animals in the facility and their weight)
- Configuration of internal structures such as pens and open walk ways as these affect air flow patterns.

5. Building Design

5.1 Siting and orientation

Building location is a critical component when relying on natural ventilation. Any structures, such as building, trees and silos, plus the natural contour of the surrounding land will disturb the airflow. Shelter can influence airflow for five to ten times its height downwind. Naturally ventilated buildings should therefore be a minimum of 20 to 25 metres apart from other buildings. Further guidance is provided in Table 5.1.

Table 5.1: Minimum Separation Distance Between Naturally Ventilated Buildings
(Adapted from *Dairy Freestall Housing and Equipment*, MWPS-7 Eighth Edition (2013), table 7-1)

| Length of nearby building (metres) | Height of nearby naturally ventilated building (metres) | | | |
|------------------------------------|---|-----|----|------|
| | 6 | 7.5 | 9 | 10.5 |
| 30 | 20 | 20 | 20 | 20 |
| 60 | 20 | 20 | 24 | 26 |
| 75 | 20 | 24 | 26 | 30 |
| 120 | 27 | 30 | 34 | 37 |
| 150 | 30 | 34 | 38 | 40 |
| 300 | 43 | 49 | 53 | 58 |

Building orientation also affects the performance of natural ventilation and detailed knowledge of the local wind conditions is, therefore, essential. Structures that rely on side and ridge vents theoretically should be sited for maximum wind exposure thereby located at right angles to prevailing winds to allow maximum opportunity for cross ventilation to establish. In this instance, the design assumes airflow will come through sidewalls or eave openings in the roof rather than end wall openings.

There has been considerable research on utilising the tunnel ventilation effect by leaving two end walls open to create a wind tunnel. The effect of this will be reduced if one end is closed off, or both closed with the option of opening through roller doors.

Open sided structures oriented north-to-south allow for more solar radiation through the sidewall openings in summer than east-to-west orientated buildings. North-to-south orientations can minimise heat stress from sun exposure.

5.2 Building openings

Figure 5.1 shows the various options for building openings.

Figure 5.1: Airflow through Building Openings (Concept Only): (a) Summer, and (b) Winter

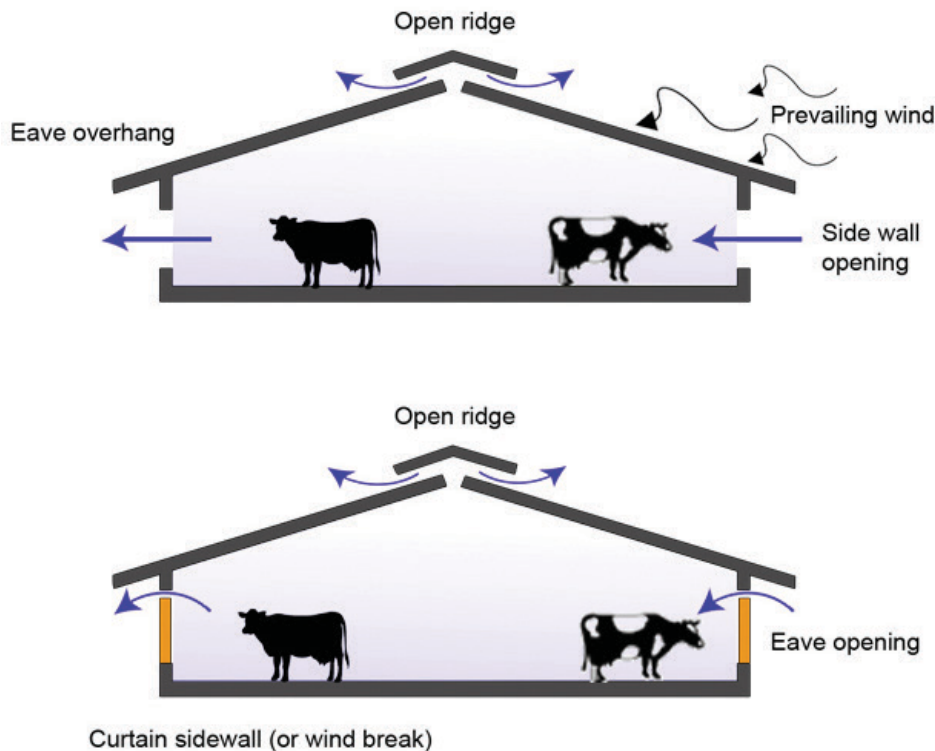

5.2.1 Roof ridge opening

Hot air and moisture rise as a natural convection process. As cows release water vapour through respiration, body heat and other gaseous discharges, this heat and moisture must escape from the structure to avoid corrosion of fixtures and fittings within the housing structure. The width of the roof ridge opening to allow heat and moisture to escape must be defined prior to determining the inlet area required in the sidewalls. Such determination is complex and dependant on many different building and site factors. Recommending roof opening sizes and their design is beyond the scope of this PN.

Often air that is naturally rising and exiting through the roof will prevent light rain and snow entering the structure. However if the ridge opening is above a freestall row, bedding, or a feed lane, then the risk of rainfall coming in can be reduced by constructing a wide raised ridge cap.

5.2.2 Automatic roof opening

An automatic opening and closing vent system built into the roof can provide a more controlled internal atmosphere. This type of roof requires sensors for temperature, wind speed and rainfall electrically linked to the automated opening controls. Opening settings need to be based on a history of ongoing monitoring and take account of variable factors such as herd size using the facility and the time of the year.

As open vents can be damaged in unusual weather events and closed vents can lead to excessive temperatures, manual roof opening must be quickly available if the automatic system fails, for example through power loss.

5.2.3 Eave opening

A continuous eave opening needs to be constructed along both sides of the building. Each eave opening area should be at least half as much as the ridge opening area. Often ridge openings are made too small to be hydraulically efficient while trying to reduce water ingress or construction cost.

5.2.4 Sidewall opening

With large sidewall openings, the designer should look to provide an overhang at the eave to provide shade and partially shield the opening from rain blowing in. An overhang of one third of the wall height has been found to be satisfactory.

Increasingly, structures are incorporating windbreaks that can be adjusted up or down depending on prevailing weather conditions. Curtain sidewalls can be used during winter to protect stock from excessive wind or rain and to reduce air speed. An effective permeable windbreak or curtain can reduce wind speed downwind at a distance of up to 30 times the barrier height. A funnelling effect can often occur during excessive wind speed events, which can cause animal health and energy loss issues. Curtains should be retracted in summer to allow airflow from cross winds through the animal zone to provide heat stress reduction.

The following components need to be incorporated if considering a windbreak on the open sidewalls of naturally ventilated structures:

- A minimum ratio of wind break length to height of 12:1
- Support posts at approximately 3 metre intervals
- A porosity/permeability of 50%.

5.2.5 End walls

End walls can provide additional ventilation, particularly in the warmer summer months. If both ends can be opened this is a distinct advantage.

5.3 Insulated buildings

Uninsulated barns will have difficulties with condensation and frost formation in climates where wintertime outdoor temperatures drop below zero for extended periods. Uninsulated barns in these climates cannot provide adequate air exchange to remove moisture given off by the animals, or keep the indoor temperature warm enough to prevent manure from freezing without supplementary heat. However, there would be very few dairying locations in New Zealand where insulation for winter conditions would need to be considered.

6. Active Ventilation

6.1 Extraction and pressurising fans

Active ventilation is where the energy to drive air exchange is provided by mechanical systems, normally electrically driven fans. The key advantage is that ventilation air exchange rates can be achieved regardless of stocking rates and external climate conditions.

6.1.1 Extraction or exhaust fans

By drawing air out of a structure using a fan mounted in a sidewall, or a roof vent, air can be drawn into the structure through ports. The fan and ports can be linked and automated for when air exchange is not required (see Figure 6.2 (a)).

6.1.2 Pressurising or ventilation fans

A fan mounted in a wall can deliver air into a structure and force air out through outlet ports (see Figure 6.2 (b)).

Figure 6.2: (a) Extraction Fan, and (b) Pressurising Fan

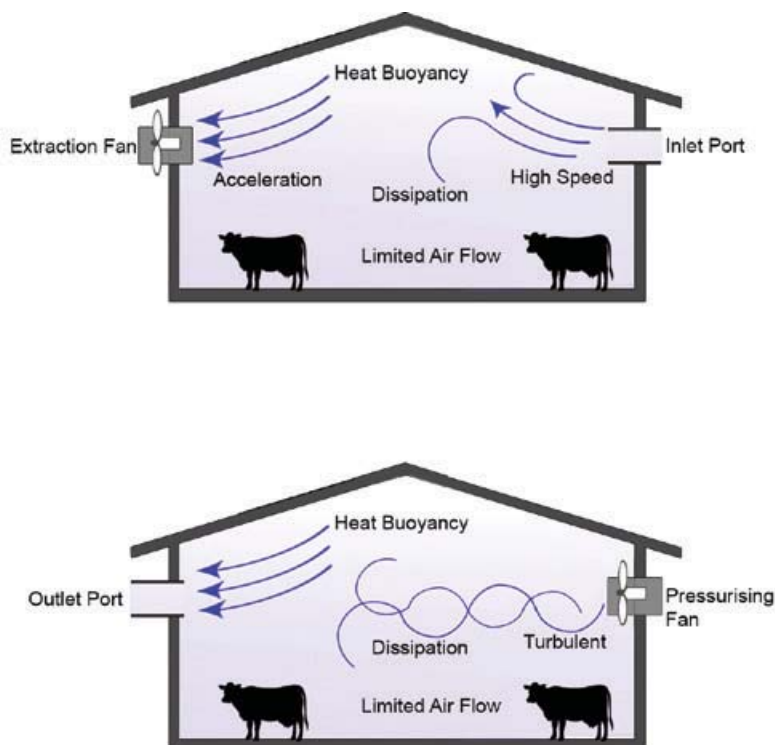

The designer must be well informed in the types of fans available for use in each of these two situations, as fans ability to “suck” or “blow” vary according to the intricacies of fan blade design and motor configurations.

The airflow patterns will be constrained by the jet velocity ability to penetrate the still air within the structure and overcome heat buoyancy affects. Air speed will rapidly decline in most instances without considerable driving force behind the jet. This can be energy inefficient and often comes at the cost of noisy fan impellers and motors.

6.2 Ducting

Both extraction and pressuring fans/port configurations can be fitted with ducting to direct air within a structure. Figure 6.3 shows a typical system.

The designer must be familiar with perforated air duct design and the impact of backpressure created by the duct on the fan performance.

An additional advantage is that if correctly designed, the fan system can also achieve the required air movement across animals independently of the need for air exchange. This is useful when external air is very cold or very hot and bringing air into the structure is undesirable.

Figure 6.3: Ducting Fitted

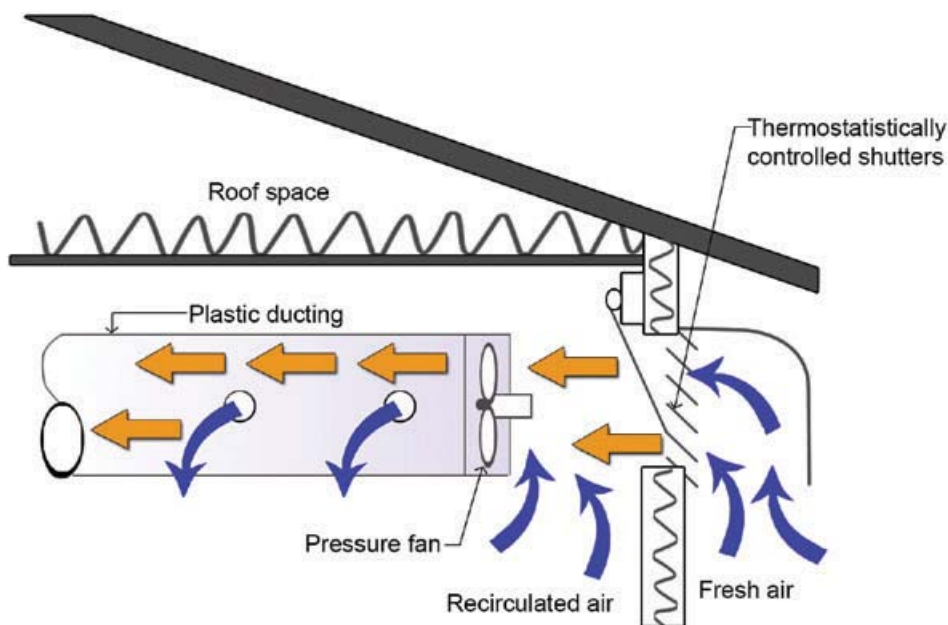

A well-designed ducted air system will provide the highest level of reliability, uniformity and ability to manage conditions within an animal housing structure. Although the initial capital outlay and complexity of the system will be higher than a passive ventilation system, the offset should be recovered in achieving better cow comfort levels on a more consistent basis with a resulting better productivity level.

7. Cooling

7.1 Cooling fans

Air movement over the cow's body increases evaporation of moisture off the skin and therefore produces a cooling effect. If air movement is not reliably achieved from other passive means then a fan may be needed. Ideally the air should move past at 2 to 5 metres per second and be activated when temperatures exceed 20 degrees. The main criteria for selecting appropriate cooling fans are:

Ability to provide a good air throw:

- Fan size
- Drive type
- Price
- Operating costs.

Supplementary cooling fans need to have good throw. Fans with more throw have a higher air velocity at a greater distance away from the fan. Fans that expel air in a tight cone should be considered. Typical fans throw air a distance equivalent to ten times the fan's diameter. There are two predominant fan types, high-speed (HS) fans and high volume low speed (HVLS) fans.

7.1.1 High speed fans

High-speed (HS) fans are more compact and operate at higher speeds. They typically shift around 600 cubic metres of air per minute. Propeller or other axial-flow fans are recommended. Typically, these fans are 0.6 to 1.3 metre in diameter and operate with 0.25 to 1.5 horsepower motors. These should be oriented in the same direction as prevailing summer winds so airflow generated by the fans supports wind driven air exchange rather than fighting against it under warm conditions. Note that supplementary fans mix the air but do not draw fresh air into a building.

In freestall barns, fans should be located over the feeding alley where cows will be standing to eat, as well as all resting areas. Conventional placement of high-speed fans is parallel to the feed line and alleys. However, this can result in air affecting the side of the first animal, which blocks airflow to the subsequent cows at the feed line or in freestalls.

7.1.2 High volume, low speed fans

These paddle like fans create air circulation through directing air flow downwards. Once air hits the floor it moves horizontally in all directions until energy is dissipated. High volume low speed (HVLS) fans are larger, typically 4.6 to 7.5 metres in diameter, than HS fans and revolve slowly while moving large columns of air at relatively low velocity of 2 kilometres per hour. A 6-metre fan will typically move around 3,500 cubic metres of air per minute.

Because of their size, these fans are often located in drive-through structures above the central passageway as illustrated in Figures 7.1 and 7.2.

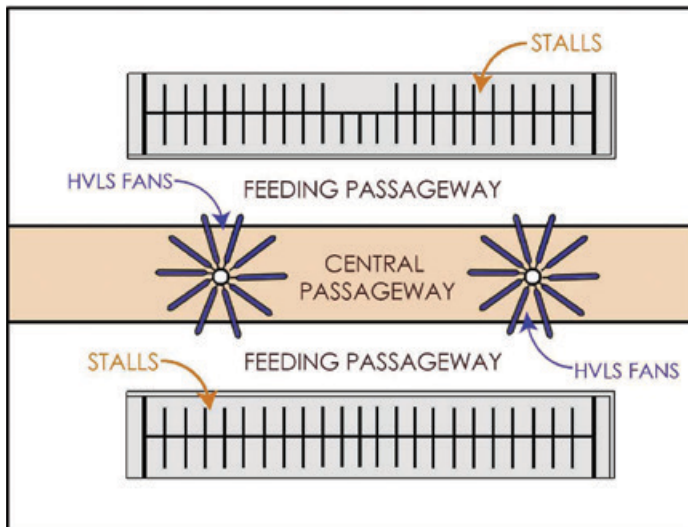
Figure 7.1: High Volume Low Speed (HVLS) Fans Installed Above Central Passageway

HVLS fans installed to high sidewalls can be used for increasing air velocity in the animal space. Air velocity becomes low beyond about ten meters from the fan.

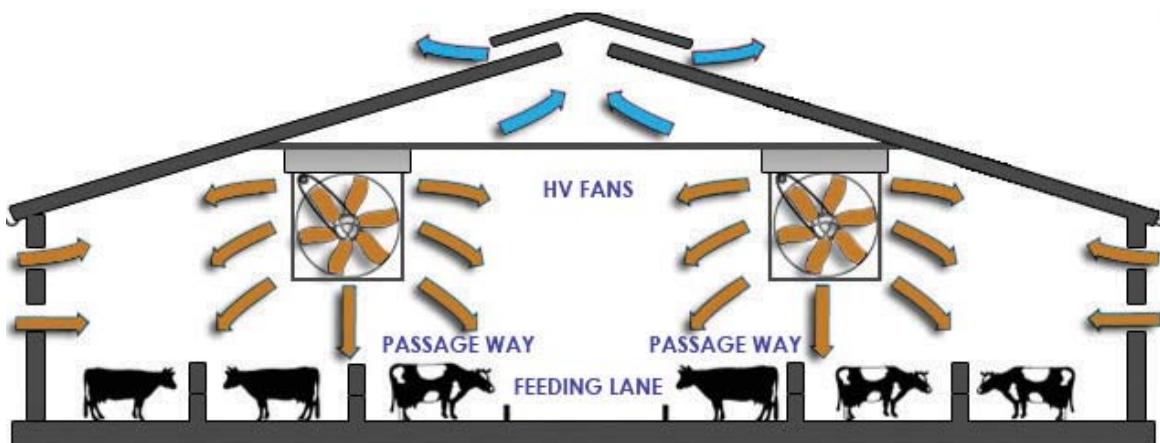
Figure 7.2: HVLS Fans Installed to Side Wall

HVLS fans are about ten times as expensive as one HS fan. However, one HVLS fan will shift the equivalent air of six HS fans. HVLS are often attractive alternatives because of their reduced electric energy cost, and reduced noise when compared to conventional HS fans. The downside is that air velocity may not be as high with HVLS fans and HVLS fans do not provide ventilation, only air circulation.

7.2 Supplementary cooling

Additional cooling infrastructure can be considered to further reduce heat stress in buildings designed with natural ventilation when shade and maximum airflow are insufficient. These supplementary cooling options may also be incorporated in the more humid summer climates of New Zealand.

7.2.1 Evaporative cooling

Evaporative cooling requires either the use of low-pressure sprinklers or high-pressure misters. They should be used in conjunction with supplementary cooling fans to increase airflow past the animal. Adequate exhaust air ventilation is essential for evaporative cooling to work properly to remove water-laden air from the structure. Without this, the humidity can continue to rise to the point of saturation that can lead to condensation on structural surfaces, corrosion, drips onto animals, mould and adherence of dust. The suggested temperature to initiate evaporative cooling is 20 degrees and higher.

7.2.2 Low pressure sprinklers

Low-pressure sprinklers are used to completely soak cows to the skin. Sprinkling is then stopped to allow the cow's body heat to evaporate the water. The humid air must be exhausted from the structure. The sprinklers can be automatically turned-on with a thermostat when a certain temperature is achieved.

Low-pressure sprinkler nozzles that produce large droplets and readily wet the cow's skin are ideal. Either 180 or 360-degree nozzles can be used depending on where they are situated. For a holding pen or lying area, 360-degree nozzles are satisfactory, but in a feeding passageway, 80-degree nozzles should be used to avoid wetting the feed. To ensure uniform distribution is achieved, supplier sprinkler information should be checked to determine nozzle spacing based on the water pressure.

Excessive sprinkling should be avoided as it can increase wetting the udder, feed and bedding, as well as increasing the amount of water entering the effluent system.

7.2.3 High pressure misting

High-pressure misting systems are designed to deliver high pressures, typically above 1,400 kilopascals, and create very fine droplets that evaporate in the air. As the droplets evaporate the air temperature is reduced a few degrees. The amount of cooling achieved depends on the air temperature, relative humidity and the amount of evaporated water. With these systems, it is essential that there are sufficient air exchanges, ventilations, to remove the humidified and heated air.

Often misting systems are installed directly on cooling fans. When designed, installed and maintained properly, a high pressure misting system can cool air around cows without wetting the cows or their surroundings. It is important to ensure pipes and connectors are designed to handle the high water pressures.

Key points

The following components must be considered when designing, constructing and operating an animal housing structure, whether passive or active ventilation is adopted:

- Proper building siting, design, construction and management can prevent most problems with ventilation systems
- Locate buildings with clear access to wind, especially summer wind
- Design and size ventilation inlets and outlets for adequate air exchange
- Avoid a site with high silos, trees or other buildings that limit airflow to the building
- Manage inlets and outlets properly. Do not permanently close openings to increase inside temperatures in winter. The result is usually a severe moisture build up, condensation on the roof and walls, high levels of ammonia odour, animal respiratory illness, and temperature rise.
- Maintain curtains and doors to minimise drafts
- Check for blocked ventilation openings. Remove dirt and debris.
- Ensure stocking density remains as designed, overcrowding can cause problems
- Monitor and manage gas levels.

References

Iowa State University/MidWest Plan Service

Dairy Freestall Housing and Equipment, MWPS-7 Eighth Edition (2013)

<https://www-mwps.sws.iastate.edu/catalog/livestock/dairy/dairy-freestall-housing-and-equipment>

MWPS-7 Eighth edition is only available by purchase.

DairyCo

(DairyCo is a division of the Agriculture and Horticulture Development Board, United Kingdom)

Dairy Housing - A Best Practice Guide, 2012

www.dairyco.org.uk/resources-library/technical-information/buildings/dairy-housing-a-best-practice-guide

DairyNZ

Dairy cow housing - A good practice guide for dairy housing in New Zealand

www.dairynz.co.nz/media/2240383/dairy-cow-housing-guide.pdf

American Society of Agricultural and Biological Engineers (ASABE)

Fifth International Dairy Housing Proceedings, 2003, pages 255-262

Nienaber, Hahn, Brown-Brandl, Eigenberg

<http://elibrary.asabe.org/abstract.asp?aid=11629>

National Animal Disease Information Service (NADIS) UK

Managing Heat Stress in Dairy Cows

www.nadis.org.uk/bulletins/managing-heat-stress-in-dairy-cows.aspx

Chapter 5
Effluent Systems

1. Effluent Characteristics

A key characteristic of Farm Dairy Effluent (FDE) is its variability. Different farms with different feed and management regimes will have quite different effluent characteristics. Furthermore, the composition, consistency and solids content of effluent on an individual farm may vary widely through the year. These changes can be frequent and abrupt as different feeds are introduced to herd diet or pasture quality changes. Table 1.2 summarises the composition of effluent solids.

Table 1.1: Terminology (For This Practice Note)

| |
|---|
| <p>Excreta is defined as the urine and dung from animals.</p> <p>Farm Dairy Effluent (FDE) is the resulting liquid when this excreta is mixed (typically) with wash water and other waste liquids, waste feed and bedding material, as well as passageway or yard rainwater.</p> <p>Manure is the semi-solid or solid part of excreta that dries before being collected and handled (for example, by scraping). Manure can also contain waste feed or bedding material and soil removed by scraping.</p> |
|---|

Table 1.2: Composition of Effluent Solids

| Types of Solids | | Considerations |
|------------------|---|---|
| Inorganic solids | <p>Solids in the form of stone, sand and grit tracked in with cows from paddocks and races to the dairy housing.</p> <p>Will reflect the local soils and the materials used on the floor surface.</p> | <ul style="list-style-type: none"> Amount of inorganic solids in the FDE can depend on frequency of in/out movement of cows from cover; minimal amounts in dry weather with larger quantities possible at wetter times of the year Effective stone removal is essential wherever an FDE system incorporates whole effluent pumping, mechanical solids separation or geomembrane (synthetic) lined ponds. |
| Organic solids | <p>Manure solids can comprise of a variety of partially digested feeds, for example, grass silage, maize, Palm Kernel Expeller (PKE).</p> <p>While these organic solids are fibrous, their length and consistency can vary with cow diet, farm management and time of year.</p> | <ul style="list-style-type: none"> The coarse fibrous nature of the FDE solids is an advantage for solids removal processes Diets of pasture fed cows through a dairy shed tend to have less fibre than dairy housing where stock are fed much more on grain and concentrates resulting in a lower dry matter manure. This difference is significant when transferring design recommendations for manure handling equipment for dairy sheds to that of housed cows. The texture of some supplementary feeds, such as PKE, is hard and can be abrasive to some pump and solid separator components. |
| Other | <p>FDE will contain a wide range of litter or debris which can include waste feed, plastics, animal waste and vegetation.</p> | <ul style="list-style-type: none"> While good housekeeping will minimise solids and litter, these materials will inevitably become incorporated into the FDE; therefore the pumping and solids removal processes need to be able to cope with these additional elements. |

1.1 Total solids

Effluent management system choices are constrained by the total solids (TS) content of the material to be handled. Figure 1.1 shows generally accepted TS limitations for different manure handling options.

The TS content of manure “as-excreted” may range from 8 per cent to 15 per cent and can therefore be described as a liquid or semi-liquid (a slurry). Material of this concentration is usually conveyed by augers or manure tankers. After passageway or yard runoff and any wash-down is added the TS content of the diluted effluent is typically less than 2 per cent.

Figure 1.1: Total Solids and Manure Handling Options

(From Dairy Australia - Effluent and Management Database for the Australian Dairy Industry)

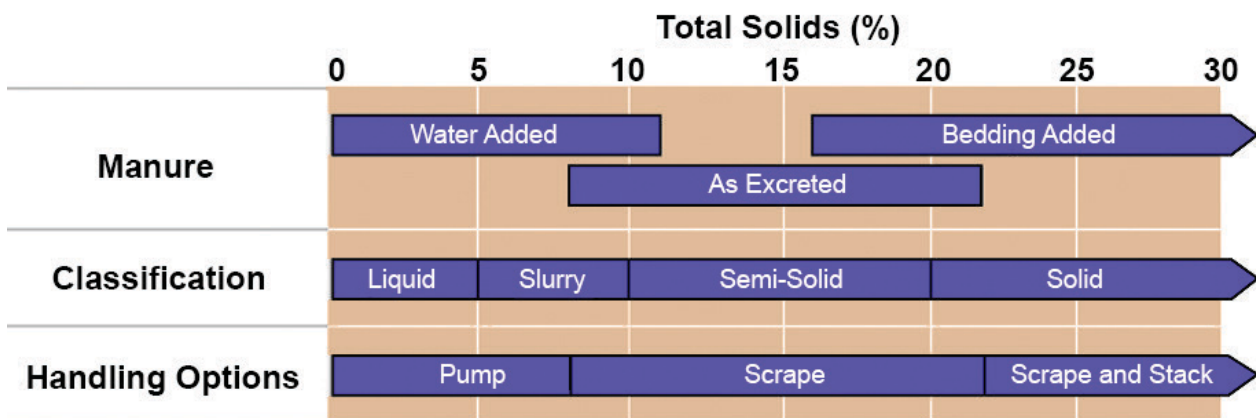

1.2 Effluent system approaches

For dairy housing the building designer must consider early in their design, which internal and external effluent system will provide the most suitable operational management. A range of approaches can be considered for the management of effluent in dairy housing. As set out in Table 1.3 these can broadly be classified as either “dry” or “wet”, or the in-between “slurry” state.

Table 1.3: Effluent System Approaches

| Fluid State | Approach |
|----------------|---|
| Dry systems | <ul style="list-style-type: none"> Slatted floors to underfloor bunkers Various configurations of composting barn systems. |
| Wet systems | <ul style="list-style-type: none"> Hand held hose Flood wash. |
| Slurry systems | <ul style="list-style-type: none"> Fixed chain/rope scrapers Mechanical plant where rubber scrapers collect the manure and wash water is used to clean down surfaces. |

Figure 1.2 illustrates FDE system options available. Propriety suppliers of effluent management systems will each have a view on which approach is preferable for different fluid states and it is outside the scope of this practice note to discuss the advantages and disadvantages of each approach. However, the reference section for this chapter does include a number of useful documents that designers and those involved in effluent systems decision making process should refer to.

Figure 1.2: Farm Dairy Effluent System Options

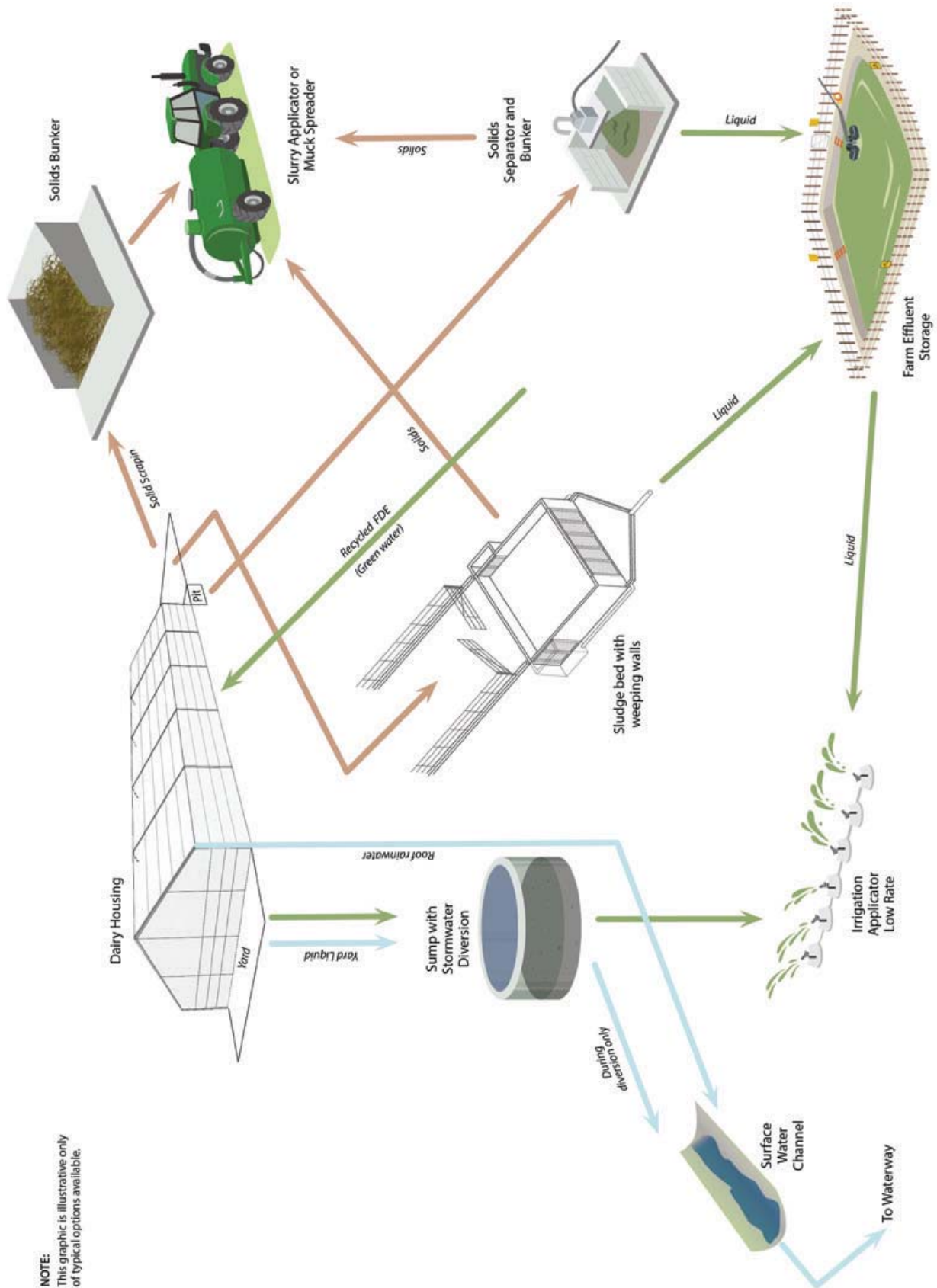

NOTE:
This graphic is illustrative only
of typical options available.

2. Dry systems

2.1 Slatted floor systems with underfloor bunker

In slatted floor systems the animals are housed on slatted floors. Excreta falls through the slats and is collected in an underfloor bunker or channel.

Concrete slatted floors provide a means by which FDE is quickly removed from the animal environment with minimal labour cost. Excreta either falls through the slatted floor or is worked through the floor by animal traffic. FDE is stored in a bunker beneath the floor or removed with flushing systems. Mechanical scrapers beneath slatted floors are not recommended because equipment repair or replacement is difficult.

Effluent from slatted floors and collection bunkers can be managed in a number of ways. The depth of the bunkers and the duration which dairy cows are housed will determine how often these systems require emptying. Often agitation will be undertaken to assist the pumping of liquid effluent out from the bunker. Alternatively an overflow pipe or sump in the bunker may be used to allow liquid to gravity flow to short term storage from where it can be either pumped and applied to land, or stored in a tank or pond. As floating solids can block pipes, readily accessible screens or other filtering arrangements should be designed into the system.

Remaining bulk solids are usually removed using a tractor mounted front end loader. Access can be gained by removing several segments of the slats. These solids are generally spread to land using a muck spreader.

Operations with deep bunker storage should consider minimising the use of sand in the freestalls. Sand that accumulates tends to settle to the bottom of the pit and can be difficult to remove. The result is a decrease in storage capacity.

Storage of effluent in bunkers beneath a slatted floor combines effluent collection, transfer and storage. However, effluent bunkers can lead to a build-up of gases and moisture in an enclosed environment. The increased concentrations of these corrosive and hazardous gases and moisture can also lead to:

- premature corrosion of metal components and fixings on the building structure
- poor working environment for farm workers
- poor air quality for cows.

During agitation and pumping, effluent related gas concentrations can become very high inside buildings without sufficient ventilation. Therefore while emptying the bunkers, it is recommended to remove all people and livestock from the building, and maximize the ventilation rate. Confined spaces can be hazardous and require specific health and safety mitigation measures. Proper management of the ventilation system (natural or mechanical) is critical to the safe operation of a slatted floor over an effluent bunker.

Table 2.1: Underfloor Manure Storage Bunker Considerations

- Will vehicles traverse the bunker floor to empty manure? If so the floors must be designed to withstand the loadings of the specific weight class of the vehicle. Vehicles are generally tractors.
- Will scrapers (on chains or ropes) be used to withdraw manure? These are generally proprietary systems to be designed according to manufacturer's requirements.
- Is flood-wash proposed to remove manure? If so then slopes and water flows for flood-washing apply.

2.1.1 Slats

The type and shape of slats have an important bearing on cow comfort, cleanliness and foot health. Slats must have solid, smooth edges and be close enough to allow the cow to walk comfortably and easily over them while, at the same time, have a large enough gap to allow slurry to fall through into the store below.

DairyCo (United Kingdom) recommend a slat width of 140 to 160 millimetres with a spacing of 35 to 40 millimetres.

2.1.2 Fibre retention

Some systems are designed to retain fibre on the slats to form a crust for bedding. In these systems the natural light and heat transmission into the housing results in a drying of the manure, and collected manure in the under-slat bunkers is firmer.

Any bunker for effluent storage beneath the housing should be designed as a liquid retaining structure. Urine and moisture from the effluent passes to the bunker and needs to be contained to ensure there is no leaching to groundwater. Specific structural and geotechnical design is required for storage bunkers. Bunkers may be relatively long structures and span varying ground conditions with potential for differential settlement.

Bunkers are usually designed with sufficient capacity to provide annual clean out intervals. Typical depths used are 1 to 1.5 metres.

2.2 Composting floors

Composting or bark floors provide a different approach to animal bedding and management of manure. In these systems a deep bed of wood/organic material is used to absorb the moisture from excreta. Systems can be designed to compost the manure *in situ*.

Typical materials for use in composting or bark floors include bark chips, post shavings, sawdust, woodwaste, straw and sand.

The type and amount of organic bedding used depends on housing type. Manure from loose housing is typically handled and stored as a solid. Manure from freestall barns is handled as a semi-solid or slurry, or as a flushed liquid. Adding organic bedding, such as straw, to manure increases the solids content.

The critical factor in achieving a satisfactory outcome for these systems is to ensure effective drainage of the bedding material. If this is not provided the bedding will saturate and rapidly become unhygienic with strong odour, high ammonia levels and poor microbiological quality. Conversely a well-drained bed will provide effective *in situ* treatment of manure maintaining aerobic conditions with minimal odour.

2.3 Tractor scraping

Manual scraping is a common method of effluent collection from freestall passageways and loose housing floors. Scraping is generally undertaken using a tractor-mounted blade or bucket, or a skid loader. To reduce polishing of a concrete floor, many dairy farmers use a rubber scraper fabricated from half of a large tyre. The tyre is bolted to a metal frame that can be mounted to the front of a tractor or a skid loader. The curved shape of the tyre results in less manure flowing out along the edges. Large, tractor mounted loaders are suitable for removing manure from outside yards and scrape passageways with straight runs and few turns. Wide front wheel spacing is desirable for stability. Using tractor-mounted loaders in buildings that require reversing down long passageways or that have restricted turning areas should be avoided. Skid loaders have a low height and a turning radius of their own length so can be used to clean manure from cramped areas, such as separate resting areas.

Removal of slurry with a tractor mounted scraper is time consuming and will place a practical limit on the number of times each day that slurry can be removed. The operation can only be undertaken when the cows are away from the housing.

2.4 Subsurface design

While some types of facilities do produce relatively small liquid flows and provide high nitrogen removal rates within the bed, seepage of effluent to groundwater is unacceptable and negates much of the nutrient management advantage of housing cows.

Therefore, all floors for any dairy housing must incorporate a near impermeable surfacing material to prevent discharge to groundwater. This is generally achieved using concrete floors but where these are not constructed other means of containment is a must. The floor drainage beneath the composting floor bed, for example, needs to be designed to provide effective removal of seepage to an effluent system.

The design and construction section of the DairyNZ publication *Stand-off pads - Your Essential Guide to Planning, Design and Management*, describes some good practice principles that are also relevant to cow housing subsurface design. Cross sections in Figure 2.1 have been sourced from this document. Table 2.2 provides some practical drainage design advice.

Figure 2.1: Example Design for Subsurface Drainage Design

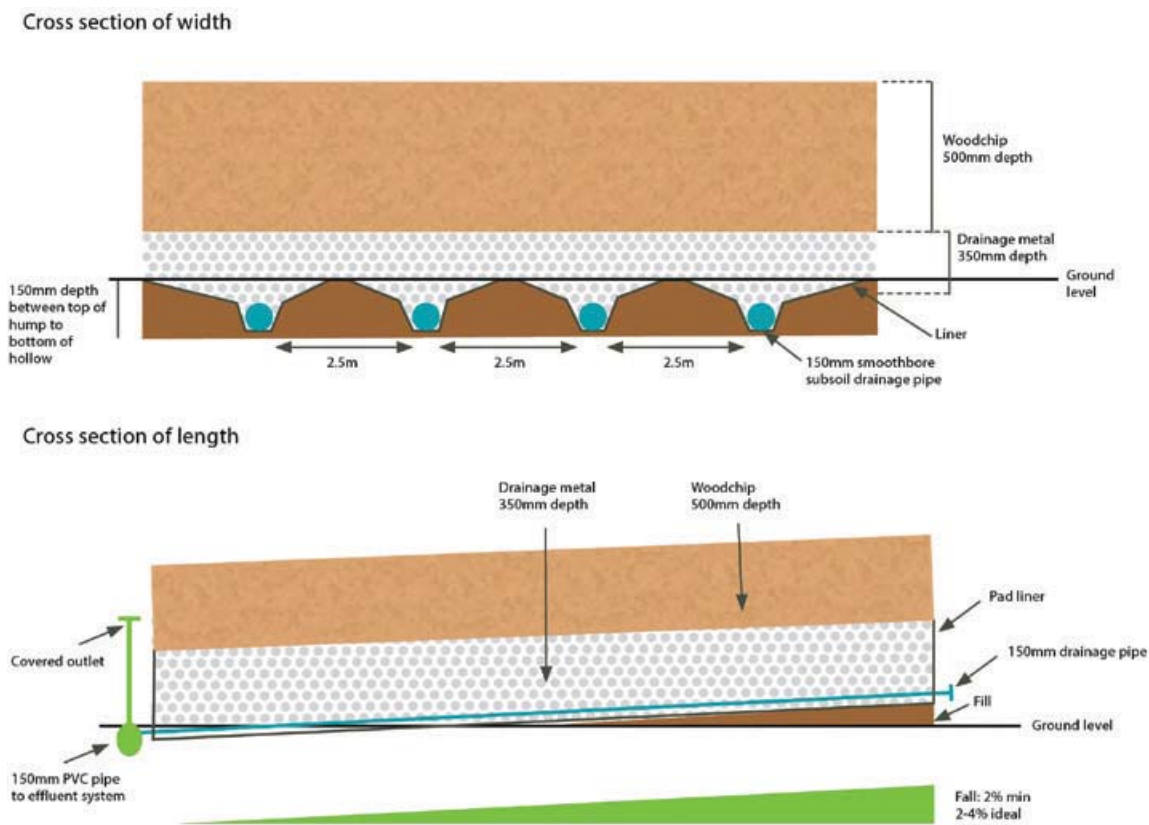

Table 2.2: Key Design Details for Drainage

- Provide 300mm minimum gravel or pumice drainage media layer below bedding and over liner. Synthetic drainage grids may be an option if suitable gravel is unavailable at reasonable cost.
- Depending upon grading and angularity of gravel or other drainage media, additional protection in the form of geofabric (or equivalent) over the geomembrane liner may be required
- Provide minimum 2% cross falls to floor base
- Incorporate slotted drainage pipes in gravel surround to form drains at low points. Drainage pipes should be drilled High-density polyethylene (HDPE) not slotted drain coil, which is more likely to crush under vehicle loads when placing/removing bedding
- Provide cleaning eyes for drainage pipes.

3. Slurry Systems

3.1 Mechanical passageway scrapers

Mechanical passageway, or alley, scrapers are one of the most commonly used effluent management systems within freestall barns. A typical passageway scraper has one or more blades, a rope, cable, chain or shaft to pull the blades, an electric motor, and controls. The rope, cable, chain, or shaft is typically recessed into a groove in the centre of the alley. The blade is wide enough to scrape the entire alley in one pass. Generally a timer will be used to operate an alley scraper at a rate of several times per day through to continuously depending on the volume and length of passage to be scraped. The longer between intervals the more FDE builds up with more wear and tear on the equipment.

Mechanical scrapers can reduce daily labour requirements. However, maintenance requirements can be high because of corrosion and deterioration due to the harsh environment and the weight which the effluent load places on the pulling mechanism.



Automatic scraper

Although these systems are usually incorporated on solid concrete and rubber lined alleys in New Zealand they can also be used if passageways have a slatted floor. Removing manure from the slates can be difficult though when effluent becomes drier due to change in feeds or in well ventilated barns in warmer climates.

Scraper designs generally rely on chains, ropes or plastic coated wires. While these systems are gentler to cow's feet than hydraulic ram systems, particularly if the chain or rope is recessed into the floor, they require maintenance. Chains and ropes can stretch and break over time.

The effective maximum operating length of these systems varies; up to 70 to 80 metres is common but longer systems are possible. A key design question will be what is the efficient length and return time for these longer systems. In dairy housing of this length where slatted floors are not used, effluent is usually scraped to a bunker or sump at the end of the structure before being transported to the effluent processing facility. Often in longer barns mechanical scrapers will scrape from both ends and meet in the middle. These systems will have a centre grate covered bunker, typically about three metres wide running across the scraper path. Once effluent has drained into this centre bunker it usually drains to the effluent processing facility.

The use of drinking water tip troughs can aid floor cleaning by assisting viscous effluent to flow more easily.

3.2 Gratings

Care should be taken in choosing width of channel, and grating tread pattern to ensure that the tread has the following characteristics:

- Non-slip when wet
- Wide enough that material is not washed over the grating
- A grating pattern that does not clog with solids/fibrous material
- Narrow spacings, and wide enough treads to ensure cows hooves are not damaged
- Designed for cow movement and comfort such that cow flow is not interrupted.
- A variety of tread patterns are available.

4. Wet Systems

Where effluent is managed using additional water to wash down passageways, slopes and flow rates need to be designed to ensure a slurry velocity is achieved that will move the material to the subsequent effluent management system.

4.1 Flood wash

Flood washing is beneficial for large collection passageways and yards, due to the difficulties of tractor scraping and the time and cost of manual hosing down. Recycled FDE, also known as green-water, can be used to conserve water. Fresh water may need to be intermittently added to ensure the green-water doesn't become an unpumpable slurry. An alternative backup system should be available in case of breakdowns.

The benefits for flood washing include:

- Labour saving compared to tractor scraping
- More frequent cleaning of passages compared to tractor scraping, often using an automatic timer to flush
- Passageways keep cleaner with improved foot health.

The possible disadvantages of flood washing include:

- If the system is operated when cows are present, floodwater will splash onto the legs, udders and often into the stalls
- Wash water is recycled dirty water, generating a risk to udder health, foot disease and an unpleasant aroma
- The risk of feed getting wet or contaminated.



Flood washing

4.1.1 Flood-wash calculations

The slope of the flood-wash passageway or yard is critical to maintain the momentum of the floodwater. A slope will maintain the momentum with a minimum volume of water.

Minimum velocity **V** of flood-wash water needs to be between 1.0 and 1.5 metres per second, and can be determined using the Manning’s equation for gravity driven open channel flow:

$$V = (R^{0.67}S^{0.5})/n$$

- where: **V** = Cross sectional average Velocity (m/s)
- S** = Surface Slope (m/m) (= fall/length of fall = slope percentage /100)
- n** = Mannings roughness coefficient
- typical values for concrete are: 0.013 (trowel finish), 0.015 (float finish surface), and 0.0175 (unfinished rough surface)
- R** = $WD / (W + 2D)$; where
- W** = width of passageway (m)
- D** = depth of flow (m)

Required flow rate (or quantity per unit of time) can be determined using:

$$Q = AV$$

- where: **Q** = Flow rate (m³/s),
- A** = Cross sectional Area of flow (m²)
- V** = Velocity (m/s)

4.1.2 Flood-wash flow rates

Flood-washed areas should be designed for water flow velocities, typically in the range of 1 to 2 metres per second, using the above calculations.

By way of an example, Figure 4.1 shows the minimum flow rate required to flush a 12-metre-wide concrete yard with a roughness coefficient (*n*) of 0.0175, a minimum flush velocity (*V*) of 1.0 metre per second, and a target minimum depth (*D*) of 50 millimetres.

To maintain a minimum 1 metre per second wash velocity on flatter slopes, a higher flow rate will be needed and this will in turn necessitate a flow depth greater than 50 millimetres. Note, in this example a slope of about 2 per cent achieves the optimal minimum flow rate required, in this case at 0.65 cubic metres per second (m³/s).

Figure 4.1: Flow Rate (m³/s) Required to Flush a 12-metre-wide Yard

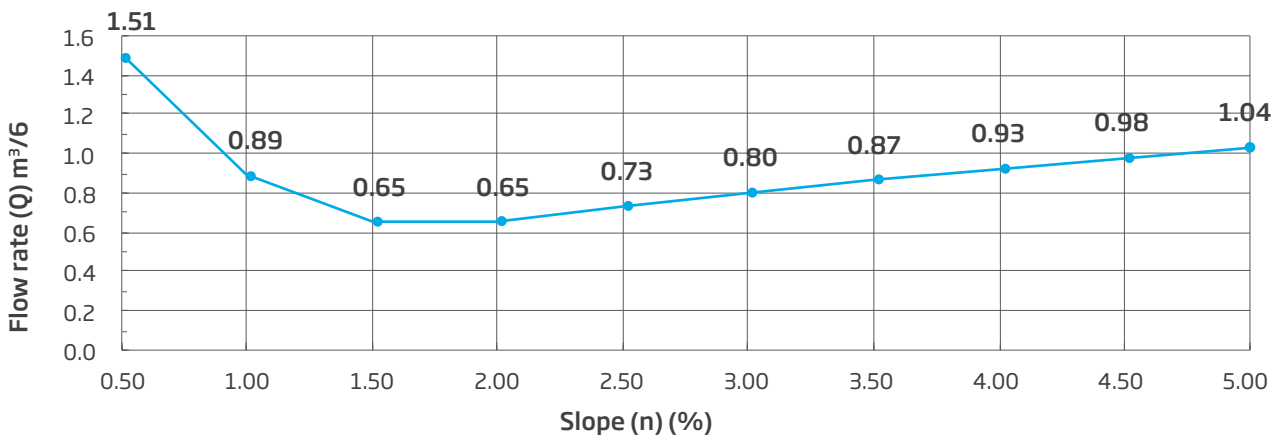

Table 4.1 gives Flow rates (Q) for various flood-wash widths and slopes based on a Depth (D) = 50mm, a Roughness (n) = 0.0175 and a minimum Velocity (V) = 1.0m/s.

Table 4.1: Estimated Flow Rates (m³/s) for Various Flood-Wash Widths (m) and Slopes (%)

| Flow Rate (Q) (m ³ /s) | | | | | | | | | |
|-----------------------------------|---------------|-------|-------|-------|-------|-------|-------|-------|-------|
| Slope (S) (%) | Width (W) (m) | | | | | | | | |
| | 4 | 6 | 8 | 10 | 12 | 14 | 16 | 18 | 20 |
| 0.50 | 0.523 | 0.769 | 1.014 | 1.260 | 1.506 | 1.752 | 1.998 | 2.244 | 2.490 |
| 1.00 | 0.304 | 0.450 | 0.597 | 0.744 | 0.891 | 1.037 | 1.184 | 1.331 | 1.477 |
| 1.50 | 0.222 | 0.329 | 0.437 | 0.545 | 0.654 | 0.760 | 0.868 | 0.976 | 1.084 |
| 2.00 | 0.216 | 0.325 | 0.435 | 0.545 | 0.654 | 0.764 | 0.874 | 0.983 | 1.093 |
| 2.50 | 0.241 | 0.364 | 0.486 | 0.609 | 0.732 | 0.854 | 0.977 | 1.100 | 1.222 |
| 3.00 | 0.264 | 0.399 | 0.533 | 0.667 | 0.802 | 0.936 | 1.070 | 1.205 | 1.339 |
| 3.50 | 0.285 | 0.431 | 0.576 | 0.721 | 0.866 | 1.011 | 1.156 | 1.301 | 1.446 |
| 4.00 | 0.305 | 0.460 | 0.615 | 0.770 | 0.926 | 1.081 | 1.236 | 1.391 | 1.546 |
| 4.50 | 0.324 | 0.488 | 0.653 | 0.817 | 0.982 | 1.146 | 1.311 | 1.475 | 1.640 |
| 5.00 | 0.341 | 0.515 | 0.688 | 0.861 | 1.035 | 1.208 | 1.382 | 1.555 | 1.728 |

Table 4.2 summarises flood-wash recommendations.

Table 4.2: Some Flood-Wash Recommendations

- Flood-wash depth minimum of 25mm, with an optimum of 50mm, and up to 75mm for heavily soiled passageways and thick manures. Note that dried manure may not be dislodged from concrete by flood-wash alone.
- Flood-wash should achieve a minimum contact time of 10 seconds (suitable for short passageways or yards); or maintain the flow rate for sufficient time for the wave front to traverse at least one-third of the passageway length (suitable for freestall passageways).
- For the example above, cleaning of the 12m wide area would require a minimum wash duration of 10s, and if the area is 30m long, a total wash volume of $0.65\text{m}^3/\text{s} \times 10\text{s} = 6.5\text{m}^3$ per wash, or 0.54m^3 per metre width would be required.
- Dairy Australia report that the required volume of water for flood-washing is typically 0.5 to 1.5 cubic metres per width of yard.
- Nib walls or other side structures need to be of sufficient height to contain the maximum wave height
- Steep slopes are unsatisfactory for stock to stand on for more than short periods.

4.1.3 Flood-wash drainage system

The channel and any sump receiving flood-wash needs to be designed so they are large enough to accommodate the whole flood-wash wave, that is holding the design volume while keeping sand suspended.

Once the required volume of water to effectively flood-wash the area has been determined, the dimensions of the receiving channel can be calculated thus:

Flood-wash volume = receiving channel volume + safety factor
 Channel cross sectional area = flood-wash volume (m³)/passageway or yard width (m)
 Channel depth = flood-wash volume/channel width

A range of proprietary effluent transporting products are available in New Zealand, ranging in width from 100 to 900 millimetres to suit a specific design. Based on the chosen width, the required channel depth can be accordingly determined.

Areas washed away from the direction of flow may require a small submersible trash pump to transport soiled water back to the FDE system. This should be located in a small sump to ensure complete transfer of the wash water to the FDE system. This is also a good location for a secondary stone/grit trap in case the wash does not drain to the main sump completely.

4.2 Recycled FDE

The amount of fresh water required per day for passageway flushing can be greatly reduced by employing green-water recycling for flushing freestall passageways, and only when cows are not inside. With recycled FDE, salt and mineral concentrations will increase and can cause pumps and distribution pipes to corrode and block.

FDE recycling requires a solids separation system to separate out the water from the solids, typically by using a mechanical separator, although a weeping wall system may achieve the same. The separated effluent is stored in a pond or tank and can also be periodically pumped to irrigation. When flushing effluent containing sand or other beddings that are difficult to flush, it may be necessary to first scrape manure and bedding accumulations from passageways and treat this separately. Such operations may benefit if dairy housing floors are sloped more steeply, so that water can be delivered at a faster rate to erode sand and manure from passageways. A 2 to 4 per cent passageway slope is recommended by DairyCo.

After solids are removed, recycled water at a velocity greater than 1.5 metres per second can be pumped directly to the passageway at a high flow velocity, or alternatively from a tall storage tank, which by virtue of the tank's height develops the required velocity head when emptied by gravity into the passageway.

Some essential practices are detailed in DairyNZ's *Using Recycled Farm Dairy Effluent Water for Yard Wash-Down* (Farmfact 6-65).

4.3 Manual wash-down

For facilities with small floor areas where wash-down is by hand-held hose, no specific design is required. However, downstream sumps must be appropriately sized to cope with the peak flow rate and volume of water generated from washing. The designer should match the sump or channel size to the effluent pump or gravity capacity and the wash-down flow rate.

With increasing regulatory restrictions being placed on extracted water quantity this method is not recommended as the primary means of effluent removal. Wetting of feed is also a risk in using this method.



FDE gravity channelled from building to pond

5. Solids Separation

This section only provides an overview of the principal solids separation methods. Solids separation is fully discussed in Part 2 of *IPENZ Practice Note 27 Dairy Farm Infrastructure* and rural practitioners involved in dairy housing should therefore refer to this industry good practice document.

5.1 Comparison of solid separation systems

The main methods of solid separations are listed in Table 5.1.

Table 5.1: Solid Separation - Methods

- Anaerobic settlement pond
- Sludge bed with weeping wall
- Scraped sludge bed with weeping wall
- Passive screen
 - Static sloping screen
- Mechanical screen (with rotating screen or auger)
 - Inclined augers
 - Horizontal screw press
 - Rotating drum screen.



Weeping wall structure

To provide a generalised comparison, Table 5.2 compares key common design and operational characteristics of the most widely used solids separation systems available.

Table 5.2: Comparison of Solid Separation Systems

| | | |
|--|---|---|
| System | Anaerobic Settlement Ponds | Sludge Bed with Weeping Wall |
| % Dry Matter (DM) in solids by mass (after) | <4% Crust semi-solid, general contents thin slurry. | 20-30% Variable. Depends on retention and input material. |
| Footprint | Large pond area required. Volume (m ³) per cow varies with region and temperature. | Large surface area required. 1.5-2.0 litres/cow/ day |
| Mechanical components | No pump required. Transfer pump required if gravity fall not available. | No pump required. Transfer pump required if gravity fall not available. |
| Operational labour input | Day to day minimal. Maintain solids filter to effluent storage pond if present. Periodic (approximately annual) a major cleanout exercise required. | Day to day minimal, some installations require clearing along wall face to maintain flow. |
| Typical maintenance and parts | Nil. | Low. Replace timber wall battens as required (5 year minimum life expected in some setups). |
| Power usage | Routine nil. Periodic substantial machine time to agitate, clean out and spread slurry. | Routine nil. Periodic substantial machine time to clean out and spread slurry. |
| Water usage | Nil | Wash down wall panel when sludge bed emptied |
| General tidiness | Large storage of anaerobic manure | Large storage of anaerobic manure |
| Potential for difficulties | Spreading of odorous slurry. Damage to pond liner during desludging. Sliming of irrigator nozzles | Spreading of odorous slurry. Damage to pond liner during desludging. Blockage of weeping wall |

| | | |
|--|---|--|
| Potential for difficulties | If screen overloads or binds up, effluent spills out into solids bunker. | Blinding of screen causing FDE to flow to bunker. |
| General tidiness | Good, some manure encrusted around screen itself, solids leach as still high moisture content. | Good, some manure encrusting around screen, solids leach at high water. |
| Water usage | Low, typically <100-200 litres/cycle depending on nozzle selection. | Wash water up to 400 litres/hour depending on drum size and loading. |
| Power usage | Low power required to provide 3 Bar pressure to wash system. Nil if feed from farm supply. | Low (relative to screw press), nominal 1.5kW for 50m ³ /hr capacity. |
| Typical maintenance and parts | Wash system. | Bearings. |
| Operational labour input | Variable depending on the wash system and FDE input stream. Some installations report weekly wash needed, others only every few months. | Weekly visual check. Annual service check of drive. |
| Mechanical components | Effluent transfer pump. Wash water system. Timers. Solenoid valves. | Effluent transfer pump. Electric motor. Gear box. Rotating drum. High pressure wash. |
| Footprint | Small, solids bunker governs size. | Small, solids bunker size governs. Machine is larger than equivalent screw press. |
| % Dry Matter (DM) in solids by mass (after) | 7-11% initially off screen. Solids contain free water and will continue to leach. | 10-15% Solids contain free water and will continue to leach. |
| System | Static Slope Screens | Rotary Drum Screens |

| System | % Dry Matter (DM) in solids by mass (after) | Footprint | Mechanical components | Operational labour input | Typical maintenance and parts | Power usage | Water usage | General tidiness | Potential for difficulties |
|-------------------------------|---|--|--|---|---|--|----------------------------------|---|--|
| Inclined Augers | 22%+ | Small, solids bunker size governs. Machine is larger, approximately 3m longer than equivalent screw press. | Effluent transfer pump. Electric motor. Gear box. Rotating auger. Back pressure. | Weekly visual check. Replace auger facings possibly up to 2-3 times per year. Annual service including check of drive. | Some installations report high wear on auger facings and screens. | Low, for example 4kW for 72 m ³ /hr capacity. | No specific wash water required. | Good, solids leach at still moderate moisture content. | Auger facing wear and screen damage, resulting in downtime. |
| Horizontal Screw Press | 30-40% Solids dry, no free water can be wrung by hand. | Small, solids bunker size governs. Machines are small relative to capacity. | Effluent transfer pump. Electric motor. Gear box. Rotating auger. Back pressure system | Weekly visual check. May need seasonal adjustment of back pressure. Annual service check of gearbox and drive. Brushes on auger may need replacing 2-3 yearly. | Brushes. | 1.5kW for 20 m ³ /hr. capacity. | No specific wash water required. | Excellent, solids dry and non-leaching, all FDE contained in machine. | Loss of plug will spill FDE to bunker. Excess back pressure may stall motor. |

Notes: This comparison excludes reference to FDE pumps for land irrigation. All mechanical options will require a transfer pump to feed a solids separator irrespective of its type but are not considered as part of this comparison.

Table 5.3: Principal Types of Mechanical Separator

Rotating screen: Effluent slurry is smeared over a mesh screen, the liquid fraction passes through the screen and the solids component is directed out of the separator where it can be stored separately.

Screw press: Effluent slurry is squeezed by a large screw shaped plunger, the liquid portion is squeezed out and the solids are directed into a separate solids area.

Both types are manufactured by a range of companies. By removing the solid portion, a 15–20% reduction in slurry volume is expected. When considering which system is most suitable, annual service, maintenance and running costs should be considered.



Solid separator with bunker and effluent storage tank

5.2 Sludge calculation

The amount of effluent generated in a dairy housing system will depend on number of cows, duration spent in the structure and to some extent feed composition. Indicative volumes of excreta for “dry” effluent management systems can be calculated using the equation in Table 5.4.

Table 5.4: FDE Solids Generated

$$V_{\text{FDE}} = \mathbf{M} \times \mathbf{T}$$

Where: V_{FDE} = FDE Solids Volume (litres/cow/day)

\mathbf{M} = Whole manure volume per hour (litres/cow/hour) [3.4*]

\mathbf{T} = Hours per cow each day (hours/cow/day) on FDE contained surface

[* For a cow excreting 55 litres of raw effluent per day over a 16 hour active period this is about 3.4 litres/hour]

For example: Effluent generated from a 600-cow herd which spends 12 hours housed per day would be:

$$600 \times 3.4 \times 12 = 24,480 \text{ litres per day.}$$

If this effluent was captured and stored in a sludge bed an estimate of the volume of solids retained is:

$$24,480 \times 20\% = 4,896 \text{ litres/day}$$

[* Percentage of manure retained in sludge bed = 20% (typically)]

5.3 Pumps

FDE is usually collected in a reception pit or tank located in the centre or at the end of the cow housing building. The size of the reception pit depends on what role it plays in the overall effluent management plan. Reception pits are dangerous work sites and may contain hazardous gases and are potential drowning sites.

Some farms design reception pits to store FDE for a few days before pumping to larger storage which eliminates daily pumping. A reception pit can be designed to provide 7 to 30 days of storage. It should be able to be agitated and pumped, or directly transfer by gravity, to storage. The type of pump required depends on the solids content of the FDE.

5.3.1 Centrifugal

A centrifugal chopper pump is commonly used with reception pits in freestall facilities. Centrifugal pumps are not positive-displacement pumps because the impeller can slip in the liquid. Centrifugal pumps typically cannot handle large solids.

Select pumps that can be easily removed outside of the pit for service and repair.

5.3.2 Positive displacement pumps

Positive displacement pumps, also known in New Zealand as progressive cavity pumps, include screw pumps, piston pumps, and augers. Screw pumps handle manure with high solids content, but the manure must be free of hard or abrasive solids. Screw pumps should not be operated dry and should have a small stream of water added directly into the pump casing during operation. Piston pumps are used to move high-solids content manure to storage. They are commonly used to transfer scraped manure to storage. Blocking of the discharge pipe can cause very high pressures, which can lead to pipe damage. Large diameter (250 to 350 millimetre) pipes are typically used and seldom block.

5.3.3 Other options for transfer

Because of its nature, sand or gravel laden manure can require special handling that minimises settling out while preventing excessive wear on the equipment used for transfer. Options include:

- Gravity flow with a sluice gate
- Cross auger
- Flush flume
- Gravity via pipe or channel
- Pump
- Auger.



Effluent pit and pump

6. Effluent Storage

Adequate effluent storage volumes must be calculated and incorporated into the system to ensure effluent is not applied back to pasture when the soils are saturated or when it is more likely to cause environmental harm.

Generally storage will incorporate FDE from both the farm dairy and the animal housing system, so must be sized with both components considered.

The Dairy Effluent Storage Calculator (DESC) should be used to determine the volume of storage required to ensure deferred irrigation can be achieved during adverse weather. Some factors which will be essential in determining minimum storage capacity will be:

- Number of cows being housed and for how many hours per day
- Volume of wash water being used for either hosing or flood-washing
- Volume of FDE able to be pumped per hour by the effluent irrigation system
- Whether the receiving soils are high risk or low risk
- Surface area of passageways and yards and other areas that collect both FDE and rainfall transferred to effluent storage.

Roofed structures should be designed to reticulate rainwater into natural waterways, not onto yards where runoff enters the farms effluent system.

It is important to think conservatively when determining how many pumping hours per day are achievable while not exceeding maximum permitted or desirable application depths on pasture. Often spring is one of the busiest times of the year and ability to actively manage effluent application may be limited.

Effluent storage and FDE application to pasture options should be discussed in detail with an accredited effluent system designer. Professional design and sign offs may be required for some effluent related systems and structures. Substantial valuable information for the design and construction of effluent storage ponds can be found in *IPENZ Practice Note 21 Farm Dairy Effluent Pond Design and Construction*.



Effluent pond under construction

7. Health and Safety

Effluent systems introduce a specific set of potential hazards to the farm dairy environment. The designer needs to consider these and ensure measures are in place to eliminate, isolate or minimise them. Specific considerations are:

Table 7.1: Health and Safety: Potential Hazards

| |
|--|
| Stone Traps |
| <ul style="list-style-type: none"> • Provide roughened surface that will allow good traction for tractor to reverse out • Install barriers, for example, removable gates and fencing to clearly delineate trap. Material in wedge-style traps can form a crust which may appear firm but is not. • Consider covers to the trap. |
| Pits and Sumps |
| <ul style="list-style-type: none"> • These are particularly dangerous, being deep, with noxious gases and containing hazardous agitation and pumping equipment. Minimise the need for entry. • Provide secure child-proof fencing, safety grates, locked gates, fall protection barriers • pontoons must be able to support service personnel safely without danger of tipping. |
| Mechanical Separators |
| <ul style="list-style-type: none"> • Any machinery such as screw presses or rotating drums needs appropriate protection (for example guards) and warning of any moving parts; this should be part of the machine design • Provide an isolating switch at the solids bunker so the machine can be easily disconnected for any servicing • Install fall protection, low slip grates and other surfaces. |
| Safety Platforms |
| <ul style="list-style-type: none"> • All separators (whether static screens or screw press/drums) mounted at height on solids bunkers must have a specifically designed working platform with secure ladder access to provide safe access for servicing. It is not acceptable practice to require farm staff to balance on narrow concrete walls or the machine frame at an unsafe height above a concrete surface to clean or service a machine. • Platforms need to be professionally designed, appropriate to the service loadings, sufficiently rigid to not vibrate with the action of the machine or pumps, and constructed from galvanised steel or other durable materials. |
| Sludge Beds, Weeping Walls and Anaerobic Ponds |
| <ul style="list-style-type: none"> • Any storage for liquid whole manure will form a crust within a few days as organic matter decomposes and rises to the surface. In time this will grow weeds, but underneath will still be liquid or thin sludge and will not support the weight of a person. Such storage needs to be well fenced and signed. As a minimum, fencing should be netting with a hot wire on top to discourage climbing over, and a secure self-latching gate. Deer height fencing is preferable, again with a hot wire on top. |
| Children Around Farm Dairies |
| <ul style="list-style-type: none"> • Farm dairies are hazardous areas and children should not be in the area unsupervised. Careful consideration, in close consultation with the farm owner, needs to be given to the risk posed by farm effluent system components and how best to minimise hazards. |

Key Points

- The designer needs to understand the farms management practices and intended use of the FDE before determining effluent systems options
- The FDE solids content produced from the farm's activities, including dairy housing, will vary through the year
- The optimal location for effluent systems and related equipment for dairy housing will depend on multiple site and operational factors, each of which needs careful consideration
- The solids management system must be designed and configured to be fail-safe
- Means of eliminating, isolating or minimizing potential health and safety related hazards must be designed into the system, especially around stored effluent
- Regional council requirements and individual farm consent conditions for effluent management vary through New Zealand
- Effluent storage and FDE application to pasture options should be discussed in detail with specialist suppliers including an accredited effluent system designer
- Professional design and sign offs may be required for some effluent related systems and structures.

References

DairyNZ

A catalogue of effluent resources available from DairyNZ is listed in:

DairyNZ: Effluent Resources - Publications and Tools Catalogue

www.dairynz.co.nz/media/195207/effluent_resources_catalogue.pdf

DairyNZ also have a dedicated webpage on effluent storage at:

www.dairynz.co.nz/environment/effluent/effluent-storage/

Other particularly relevant DairyNZ effluent systems publications include:

Stand-Off Pads - Your Essential Guide to Planning, Design and Construction

www.dairynz.co.nz/publications/farm/stand-off-pads/

A Farmer's Guide to Managing Farm Dairy Effluent

www.dairynz.co.nz/media/195210/4A-Farmers-Guide-To-Managing-Farm-Dairy-Effluent.pdf

Farmfacts: Effluent Management

www.dairynz.co.nz/publications/farmfacts/effluent-management/

- 6-10 Maintenance Tasks for Effluent Ponds and Storage
- 6-11 Effluent Storage Management
- 6-12 Effluent Odour Management
- 6-13 Designing an Effluent Storage Pond
- 6-14 Effluent Pond Lining Options
- 6-15 Dairy Effluent Storage Calculator
- 6-16 Effluent Sumps
- 6-25 Effluent Stone-Traps
- 6-26 Passive Systems for Effluent Solids Separation
- 6-27 Effluent Solids Separation Using a Mechanical System
- 6-28 Effluent Slurries, Sludge and Solids Spreading
- 6-29 Effluent from Off-Grazing and Wintering Facilities
- 6-64 Safety and Effluent Management
- 6-65 Using Recycled Farm Dairy Effluent Water for Yard Wash-down

Farm Dairy Effluent - How to Use the Dairy Effluent Storage Calculator (DESC)

www.dairynz.co.nz/publications/environment/how-to-use-the-dairy-effluent-storage-calculator-desc/

Farm dairy effluent system design accreditation programme

Accredited Companies

<http://effluentaccreditation.co.nz/accredited-companies/>

AgResearch

Characterising Dairy Manures and Slurries, Envirolink tools report AGRX0901 October 2011

www.envirolink.govt.nz/PageFiles/31/Characterising%20Dairy%20Manures%20and%20Slurries.pdf

Dairy Australia

Effluent and Manure Management Database for the Australian Dairy Industry

www.dairyingfortomorrow.com/index.php?id=48

DairyCo

DairyCo is a division of the Agriculture and Horticulture Development Board, UK

Dairy Housing – A Best Practice Guide, 2012

www.dairyco.org.uk/resources-library/technical-information/buildings/dairy-housing-a-best-practice-guide/#.VKnxdaP29D8

IPENZ

IPENZ Practice Note 21: Farm Dairy Effluent Pond Design and Construction

www.dairynz.co.nz/page/pageid/2145880258?resourceId=686 or

www.ipenz.org.nz/ipenz/forms/pdfs/PN21_Dairy_Farm_Effluent_Pond_Design.pdf

Chapter 6
Site Selection

1. Introduction

When selecting a site for a dairy housing structure there are many site factors to consider. There are the practical issues around siting for efficient farm operation but also design and site constraints specific to the site chosen. If these are not sufficiently considered, investigated and analysed prior to commencing construction, there is a risk of expensive remedial work.

Critical site selection criteria include wind, earthquake, snow, corrosion and geotechnical factors.

Once the preferred site is selected, site specific factors such as shelter and the orientation of the building must be considered. Section 5 of the "Ventilation" chapter discuss these further.

A key point in design development is that a building designed for one location may not be suitable for another. A "standard" design may need substantial modification to meet the constraints of the specific site selected.

The Building Research Association of New Zealand (BRANZ) website www.branz.co.nz has some good information relating to site selection, some of which has been reproduced in this chapter.

BRANZ Maps provide free online access to its Geographic Information System software by following the steps in Table 1.1. For New Zealand it provides information on:

- Earthquake zones
- Corrosion zones
- Wind regions
- Wind zones
- Climate zones
- Rainfall Intensity.

Table 1.1: BRANZ Maps

| Step | Go to | Actions required to access BRANZ Maps information |
|------|--------------------|--|
| 1 | BRANZ Maps website | For electronic versions of this document click on the following link: www.branz.maps.arcgis.com/apps/webappviewer/index.html?id=1bade5ce36a9459aa0de4bd5cecd6e36 Alternatively, insert the words "BRANZ Maps" into an internet search engine and select "ArcGIS Web Application" |
| 2 | Address search | Insert required New Zealand location, select an available location |
| 3 | Layer list | Tick the required operational layers, for example, wind zones. Note: Map information will be presented more clearly if the number of operational layers is minimised |
| 4 | Legend | Compare zone colour with that shown in the legend to determine the zone classification for the selected location |

2. Wind

Wind loadings are likely to be the most limiting of all environmental factors in the structural design of dairy housing buildings.

Wind direction, frequency and speed (see Table 2.1) will influence a building design including its bracing requirements, roof and wall cladding selection, building entry locations, opening placement and their sizes.

Uplift from negative pressure (suctions) on agricultural buildings is an area of increasing industry concern in New Zealand building design. The problem particularly affects the cladding, purlins and girts in lightweight farm buildings, which are typically designed to use the minimum amount of materials to reduce cost.

Table 2.1: Factors Influencing Wind Speed

| Regional and site features | Comments |
|---|---|
| General wind speeds in the region | Source information from: <ul style="list-style-type: none"> National Institute of Water and Atmospheric Research (NIWA) MetService. |
| Level of site exposure | Determine from on-site observation |
| Terrain | Note that wind speed will: <ul style="list-style-type: none"> Increase as it passes over or between hills Slow down as it passes over rougher terrain - drag effect Accelerate over open and flat expanses of land or water. |
| Large expanse of water nearby, for example, sea or a lake | During the day, solar gain will heat the land mass, resulting in an increase in temperature relative to an adjacent large body of water. As air warmed by the land rises, cooler air from over the water will replace the rising air, resulting in the generation of afternoon, on-shore breezes. |
| Adjacent buildings/ vegetation | Note that wind speed: <ul style="list-style-type: none"> Is lower when a site is surrounded by taller buildings or obstructions Will increase where it funnels around or between buildings Is slowed by trees and vegetation. |
| Building height | The higher the building, the more exposed it will be to higher winds, particularly where the building is taller than adjacent buildings or vegetation. |
| Other aspects | <ul style="list-style-type: none"> Direction of the strongest wind Direction of the coldest wind Humid/dry winds Wind that comes off the sea - spray issues Wind direction that brings most of the rain. |

NZS 3604, divides New Zealand into two wind regions (A and W), and several lee zone areas where the landforms create localised wind acceleration resulting in higher wind speeds than the rest of the region. These are reproduced on BRANZ's *level* website and can be accessed by following the actions in Table 2.2.

Table 2.2: New Zealand Wind Regions Map

| Actions required to access BRANZ level Wind Regions Map | | |
|---|--------------------------|--|
| For electronic versions of this document | Click the link: | www.level.org.nz/fileadmin/downloads/Site_Analysis/Wind_regions_and_Lee_Map.pdf |
| Alternatively | Internet search on: | www.level.org.nz |
| | then, Website search on: | Wind regions and Lee map |

2.1 Gathering local wind condition information

An assessment of wind effects must be made early in the design process. This should include the average and peak speed, the wind direction, and how it affects the site at different times of year.

Site visits and discussions with farm owners and managers will usually provide a good indication of wind speed and predominant or strongest wind direction. Observe vegetation and features on the site. Talk to neighbours and observe how neighbouring properties deal with the effects of wind. Indicators of high wind speeds include:

- A general lack of developed planting
- Stunted tree and shrub growth
- Wind break fences on adjacent properties
- Wind shaping of existing planting.

Local councils should be able to give advice on the wind zone of any property within its boundaries. Some local authorities have this information online. A land information memorandum (LIM) may contain information about the property's wind zone.

The National Institute of Water and Atmospheric Research (NIWA: www.niwa.co.nz) provides climate station data for its climate stations throughout New Zealand, which includes wind speeds, number of gale days per month and wind roses which are diagrammatic representation of historical wind patterns.

2.2 Wind zone classification for design

A six-step process as listed in Tables 2.3 and 2.4 to determine the wind zone classification for the design of a timber-framed building not requiring Specific Engineering Design (SED) is included in NZS 3604, section 5.

Table 2.3: Determination of Wind Zones (from NZS 3604:2011 Timber-framed buildings, section 5, table 5.1)

| Steps | Determine: |
|-------|-------------------|
| 1 | Wind region |
| 2 | If in a lee zone |
| 3 | Ground roughness |
| 4 | Site exposure |
| 5 | Topographic class |
| 6 | Wind zone |

Table 2.4: Wind Zone Classifications
(from NZS 3604:2011, Timber-framed buildings, section 5, table 5.4)

| Classification | Maximum ultimate limit state speed (metres per second) |
|---|--|
| Low | < 32 |
| Medium | 37 |
| High | 44 |
| Very High | 50 |
| Extra High | 55 |
| Specific Engineering Design | >55 |
| Winds in lee zones are increased as follows: <ul style="list-style-type: none"> • Low wind becomes High • Medium wind becomes Very High • High wind, and above become SED. | |

This calculated wind zone value can be a major determinant of the structural design and hence cost of any new dairy housing building. Therefore, where there are several possible sites for a new building, selecting a site with a lower wind zone value may be advantageous.

2.3 Specific engineering design

For buildings which NZS 3604 is not applicable for, AS/NZS 1170 Structural design actions are the relevant set of design standards to adopt.

AS/NZS 1179.2 offers a design process for structures subject to wind action. It covers structures less sensitive to wind action through to those on exposed sites where dynamic response must be allowed for.

New Zealand is categorised into wind regions as shown in Figure 2.1, each of which is assigned design regional wind speed values based on peak gust wind data. Wind direction multipliers are provided to allow for the prevailing wind direction at a site. Expected site wind flow conditions taking into account the terrain/height, shielding and topography can also be accounted for. These are complex calculations and are best undertaken by a structural engineer.

Figure 2.1: Wind Regions (illustrative only and may be subject to future change)
 Adapted from AS/NZS 1170.2: 2011 Fig 3.1(B))

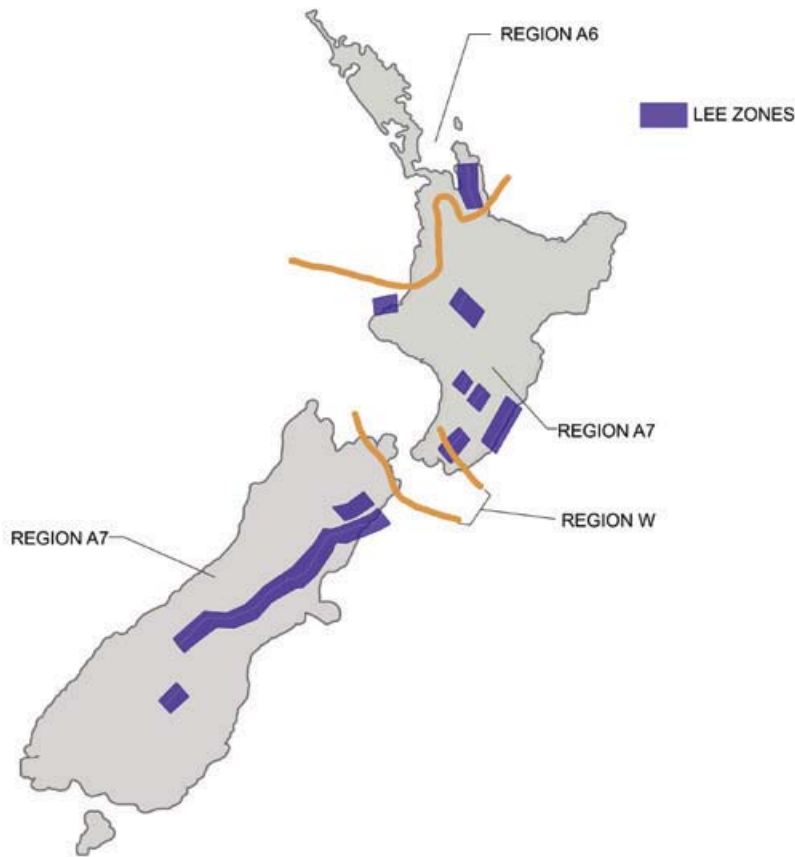

2.4 Wind effects on pitched roofs

Wind flow changes speed as it passes over and around a building, particularly as it accelerates over a roof as illustrated in Figure 2.2. The wind flow over a roof causes localised pressure reductions that create an upward force on the roof surface. This is the same effect that enables the airflow across a wing to lift an aircraft.

Figure 2.2: Wind Accelerating Over a Building

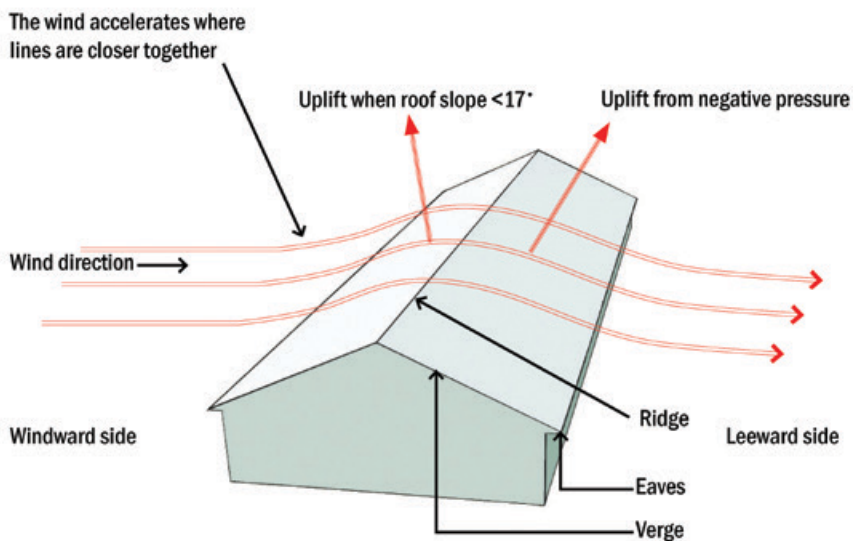

The roof pitch, wind speed and direction are the key determinants of how the wind will act on a roof structure. Roof pitch significantly impacts the pressures imposed as shown in Table 2.2, as do sharp edges, corners and appendages such as eaves. Variable pressures occur by the disruption of wind flow, fluctuating wind speeds and the creation of vortices and eddies.

The most vulnerable parts of a roof from pressure is at the edges, in particular, eaves and verges, and to a lesser extent, ridges.

Table 2.2: Effect of Roof Pitch on Windward and Leeward Side of Roofs

| Roof Pitch (degrees) | Effect on Windward Slope | Effect on Leeward Slope |
|----------------------|----------------------------------|-------------------------------|
| <17 | Uplift from negative pressure | Uplift from negative pressure |
| 17-30 | Uplift or downwards | Uplift from negative pressure |
| >30 | Downwards from positive pressure | Uplift from negative pressure |

2.5 Roofing

Lightweight roofing, such as profiled sheet metal, is more easily lifted by strong winds than other heavier roofing materials.

Where failure of the roof cladding occurs, it is generally because:

- Fixing of the roofing to the purlin or batten is inadequate
- Fixing or cladding has deteriorated
- Span for the roofing profile and wind zone has been exceeded.

Critical to roof performance under wind loads are the fixing or attachment of:

- Purlin or batten to the rafter/top chord
- Rafter or trusses to the top plate
- Top plate to the studs.

Details of the requirements for these connections are given in NZS 3604 and depend on the wind zone the building is constructed in. For specific engineering design, the connections will need to be specifically engineered to accommodate the design wind speeds.

3. Earthquake

Earthquakes, or seismic events, can bring rapid, violent shaking both horizontally and vertically. In some areas, especially hillsides, unstable ground may slide and rocks may fall. On flat ground where there is a high water table and the soil is low-density sand or silt, liquefaction can take place. Liquid is forced to the surface, carrying sand and silt with it; land can slump; surface soil close to sloping ground, such as stream banks, can spread, with cracks opening up. Depending on the location, earthquakes can bring other hazards such as tsunamis.

Because most dairy building structures are relatively light weight, it will usually be wind loads that will govern building design rather than earthquakes. Nonetheless, earthquakes and the structural detailing suitable to meet New Zealand standards for loading should be considered, especially in higher seismic risk areas.

3.1 Earthquake zones

Table 3.1 provides links to the *New Zealand Earthquake Zones Map* which gives an indication of relative earthquake risk across New Zealand with Zone 1 being the lowest risk and Zone 4 the highest.

Table 3.1: New Zealand Earthquake Zones Map

| | | |
|---|---|--|
| For electronic versions of this document | Click the link: | www.level.org.nz/fileadmin/downloads/Site_Analysis/Earthquake_Zones_Map.pdf |
| Alternatively | Internet search on: then, Website search on: | www.level.org.nz <i>Earthquake Zones Map</i> |

The motion of the surface shaking above underlying rock in an earthquake is dependent on the depth and flexibility of the soils between. The design of a building structure therefore needs to be assessed in terms of:

- Earthquake zone
- Subsoil type on which the building sits
- Level of the building
- Building size
- Roofing and cladding weights
- Floor live loads.

Under NZS 3604, bracing must be provided for all buildings, with greater bracing required for buildings in a higher earthquake zone, or where heavy roof and/or wall claddings are specified. Bracing demand is based on the type and depth of soils over rock that a building sits on and is applied using the site subsoil classification. Interestingly, the earthquake forces in buildings on Class D and E sites can be significantly greater than on rock sites as demonstrated by the relative differences between the multiplication factors shown in Table 3.2.

Table 3.2: Soil Class (adapted from NZS 3604:2011 Timber-framed buildings, C5.3.3 and Table 5.8)

| Multiplication factors | Earthquake Zone | | | |
|----------------------------------|-----------------|-----|-----|-----|
| | 1 | 2 | 3 | 4 |
| Soil class (soil classification) | | | | |
| A, B: Strong Rock, Rock | 0.3 | 0.5 | 0.6 | 0.9 |
| C: Shallow soil | 0.4 | 0.6 | 0.7 | 1.1 |
| D & E: Deep or soft, very soft | 0.5 | 0.8 | 1.0 | 1.5 |

Alternatively, site classifications determined by SED require geotechnical investigation or specialist knowledge. Such determinations requiring calculation and design are beyond the scope of NZS 3604 Timber-framed buildings and are likely to be checked by the building consent authority (BCA) as part of its consenting process.

3.2 Other seismic related risks

Usually the preferred site on the farm for a new dairy housing structure is determined by operational efficiency, but this does not preclude the need for careful consideration of potential seismic related factors during the site investigation phase, for example:

- Low-lying coastal sites have potential for tsunami damage, particularly in vulnerable Pacific Ocean-facing areas and at the head of long tapering inlets
- Low-lying riverside sites, particularly adjacent to estuaries, can be vulnerable to liquefaction. The key drivers of liquefaction are a high water table and loose fine-grained soils.
- Hillside sites require extra care to achieve seismic resilience. Unless the land is potentially unstable, the engineering problems can usually be solved. However, usually the added complexity brings increased building costs.
- The LIM for the property may provide an alert to location risk related issues, but it is usually worthwhile checking the territorial authority's hazard maps as well.

4. Snow

Agriculture buildings can have very large total roof areas. In parts of New Zealand where snowfall depth can occasionally be high, the snow loadings on the roof area from such an event can be significant. Therefore, the design of the roof structure must allow for snow load. This might include incorporating into the building design a steeper roof, or avoiding internal roof valleys and stepped roofs to provide some mitigation to snowfall damage risk.

To reflect variable snow loadings through New Zealand NZS 3604:2011, figure 15.1 divides the country into zones. These can be viewed by following the link in Table 4.1.

Table 4.1: New Zealand Snow Zones Map

| | |
|---|--|
| Click the link: | www.level.org.nz/fileadmin/downloads/Site_Analysis/Snow_Zones_Map.pdf |
| Internet search on: then, Website search on: | www.level.org.nz Snow Zones Map |

This map also provides a table of minimum snow loadings required relative to both altitude and zone which is reproduced in Table 4.2. Increasing zone numbers correspond to increasing snow risk from north to south in New Zealand. Increased altitude corresponds to the requirement for increased design snow loadings for buildings.

Table 4.2: Snow Loadings

| Snow Loadings | | | |
|---------------|---------------------------|---------|-------|
| Zone | Maximum altitude (metres) | | |
| | Up to 1 kPa | 1.5 kPa | 2 kPa |
| N0 | 400 | 600 | 850 |
| N1 | 400 | 600 | 850 |
| N2 | 400 | 600 | 850 |
| N3 | 100 | 200 | 350 |
| N4 | 200 | 300 | 400 |

Altitudes above the values given for 2 kPa require specific engineering design.

The Pascal (Pa) is a standard unit for pressure. One kiloPascal is roughly equivalent to the pressure exerted by a mass of 100 kilograms on an area of one square metre.

For NZS 3604 Timber-framed buildings a BRANZ study ("Snow Loading", 1 June 2011, *Build 124*) revealed that, up to 1 kPa of snow, wind loads, dead loads and concentrated live loads dominated over snow loads on the sizing of (building frame) members. In other words, for up to 1 kPa of snow, there was very little reduction in member spans required.

A provision in NZS 3604 Timber-based buildings is included to account for the extra depth of snow that drifts onto a lower roof abutting an upper wall (see Figure 4.1, adapted from NZS 3604:2011, figure 15.2). This results in span reductions for some members, such as purlins and rafters, in the higher snow load regions.

Figure 4.1: Roof Abutting Upper Wall,

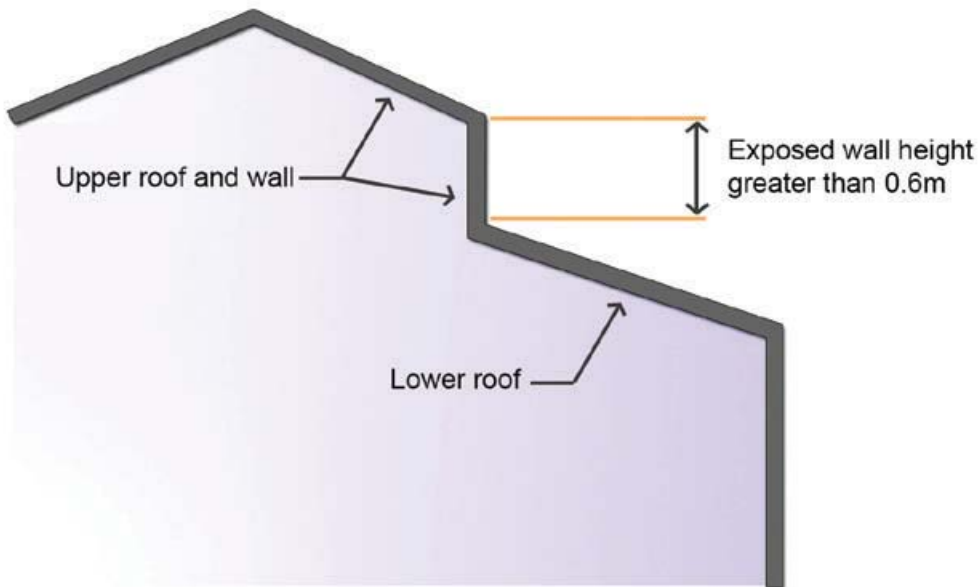

AS/NZS 1170.3 sets out procedures for determining snow and ice actions for use in the limit states design of structures to such actions. Designers should use this standard for structures that do not fall within the scope of NZS 3604 Timber-framed buildings.

AS/NZS 1170.3, supplement 1 provides further useful information on the architectural design of buildings subject to snow loading.

5. Corrosion

Rates of corrosion deterioration in steel materials vary depending on their location in New Zealand. This is illustrated in the maps below. The highest corrosivity areas are those near the Taupo Volcanic Zone and the coast. The corrosion process is accelerated by even very low concentrations of impurities in the atmosphere, such as sulphur (acid rain from geothermal areas), sulphides (FDE), and chlorides (sea salt). However, prevailing winds can drive corrosive salt air some distance inland from the coast, particularly along the West Coast of the South Island and in the more exposed parts of Northland.

Steel corrosion is further explored in section 7 of the chapter “Building Structure” in this Practice Note.

5.1 Corrosion zones

Three exposure (or corrosion) zones, Zone B, Zone C and Zone D, are shown on a map of the North and South Islands in NZS 3604:2011 Timber-framed buildings, figure 4.2 (links are provided in Table 5.1).

Table 5.1: New Zealand Exposure Zones Map

| | |
|---|--|
| Click the link | www.level.org.nz/fileadmin/downloads/Site_Analysis/Exposure_Zone_Map_North.pdf www.level.org.nz/fileadmin/downloads/Site_Analysis/Exposure_Zone_Map_South.pdf |
| Internet search on: then, Website search on: | www.level.org.nz <i>Exposure Zone Map North</i> <i>Exposure Zone Map South</i> |

The zones relate to the severity of exposure to wind-driven salt, with Zone B being low risk, Zone C medium risk and Zone D high risk. Zone D includes the following areas:

- All offshore islands
- Within 500 metres of the coastline of New Zealand, including harbours
- Within 100 metres of tidal estuaries and sheltered inlets.

This information should be used to select materials for a structure. Where there is higher corrosion risk, steel components such as roofing iron, fixings and fasteners will need a higher level of protection. Greater use of stainless steel and non-ferrous metals and timber should also be considered.

6. Geotechnical

6.1 Site conditions and ground stability

A thorough investigation and assessment of ground conditions and stability is essential to determine whether a site is suitable for building on, the best place to locate a building and the type and size of foundations required.

Inadequate bearing or ground instability may result in building failure and advice should be sought from a structural or geotechnical engineer.

6.2 Preliminary survey

A preliminary survey of the site should be undertaken with investigation of:

- General landforms
- Flooding risk
- Evidence of a risk of landslide or subsidence
- Soil types for load-bearing capacity
- Drainage and runoff
- Depth of the water table, and presence of natural springs or waterlogged soils
- Proximity of the site or proposed building to excavations or exposed banks
- Any presence of expansive clays
- Previous use of the site such as buried structures, contamination, earthworks and uncompacted fill.

6.3 Bearing pressure

The bearing pressure of soil is its ability to carry the load of a building without excessive settlement of more than 25 millimetres. Bearing pressure depends on soil type and must be assessed at the base of the foundations.

Good ground is defined in NZS 3604 Timber-framed buildings as soil that has an ultimate bearing pressure of 300 kilopascals.

Evidence of good ground includes where there is:

- No signs of settlement or inadequate bearing of foundations of adjacent buildings
- No evidence of landslides in the vicinity
- No evidence of buried services
- No organic soil, peat or soft clay.

A dynamic cone penetrometer or scala penetrometer test can be used to establish good ground. During test pit investigations, unless rock is encountered, the tip of the penetrometer should be driven below the underside of the proposed footing or pile to a depth not less than:

- (a) 2 metres for strip or pile dimensions
- (b) 600 millimetres below the actual depth of the pile for short driven-timber piles.

If the ground does not meet the bearing pressure from the penetrometer test or the building is outside the scope of NZS 3604, the ground condition must be assessed by a geotechnical or soil engineer.

6.4 Soil types of insufficient bearing pressure

Soil types that have insufficient bearing pressure include peat, sand and expansive clay.

PEAT

Peat occurs in low-lying areas and consists of compressed dead vegetation that has been preserved from decay by acidic groundwater. Although the surface of the ground can appear stable and dry, peat may be present in a deep layer that will compress under the weight of a building.

If the presence of peat is suspected, consult a soil engineer. The extent and depth of the peat will need to be determined by drilling bore holes. A thin layer of peat may be able to be removed to expose firmer soil below. Alternatively, a specifically designed raft foundation and floor slab may be needed.

SAND

Sands vary in particle size and in compaction, and some types of sand have low bearing capacity. Piles driven down to a good bearing layer may be required in conjunction with a concrete slab if the soil type is sand.

EXPANSIVE CLAY

Expansive clay increases significantly in volume when wet and shrinks again when dry.

When expansive clay extends a significant depth below the surface, particularly if it occurs at a depth where the water level fluctuates, substantial uplift of the ground's surface may occur during wet periods, followed by subsidence during dry periods. The amount of uplift will vary according to the clay content of the soil but may be up to 50 millimetres.

Building on a clay soil will affect the ground moisture content and result in a different pattern of expansion and contraction. Moisture content will also be reduced by large paved areas, tree planting and subsoil drainage. If expansive clay is present, a structural or geotechnical engineer should be consulted.

6.5 Fill

If the building site contains areas of fill, whether excavated and relocated on the site or imported from another location, it must comply with NZS 4431:1989 Code of practice for earth fill for residential development.

A code compliance certificate (CCC) should be obtained, but if this is not available, tests must be carried out to determine the bearing capacity of the fill. Generally, fill is unlikely to meet the required bearing capacity so foundations must pass through the fill to solid bearing below.

6.6 Water table

A high groundwater table means the water pressure in the soil is high and that the soil is likely to be correspondingly weaker. High water pressure will also adversely affect the stability of sloping ground and increase the loading on any wall retaining the sloping ground.

If the building site is surrounded by areas of higher ground, underground water will tend to flow to the site. This may cause pressure beneath a concrete floor slab or increased moisture levels beneath a timber floor. It can also cause water to be driven into timber piles. In this situation, subsoil drainage may be necessary.

Indications of a high groundwater table include:

- Reeds or other wet area vegetation
- Surface water or boggy ground
- Springs.

A high groundwater table is likely to mean the construction will be more difficult, and it may be necessary to pump excavations and provide drainage to remove the water, which will generally result in additional costs.

Further, while water tables may not intersect the main structure footings, they can make construction of effluent sumps very difficult. The cost of dewatering pumps versus constructing a higher building floor level using imported fill may need to be considered.

6.7 Test pits

Information about the history of the site from documents such as a Project Information Memorandum (PIM) or Land Information Memorandum (LIM) may confirm that a site has subsoil suitable for the proposed building work, but if there is doubt about good bearing, test pits (trial hole) must be dug in order to take soil samples at lower levels.

When digging test pits, record:

- Date of excavation
- Location of pit on the site
- Relative level of pit if the ground is not flat
- Overall dimensions and depth of pit
- Excavation system used
- Ease of excavation
- Rainfall that occurred while the pits were being dug
- Groundwater conditions and water table level, if found
- Soil descriptions and depth of each layer
- Positions from which samples were taken.

Soil description should follow the New Zealand Geotechnical Society (NZGS) report “Field Description of soil and rock - Guideline for the field classification and description of soil and rock for engineering purposes”.

Table 6.1: Soil Descriptions

| Field descriptions of soils |
|---|
| <ul style="list-style-type: none"> • Organic soils including topsoil, organic clay, silt, sand, or peat • Very soft cohesive soil easily exudes between fingers when squeezed • Soft cohesive soil is easily indented by finger pressure • Firm cohesive soil can be indented by strong finger pressure, or by thumb pressure • Very loose non cohesive granular materials when penetrometer readings are fewer than 3 blows per 100mm • Fill materials, except where a certificate of suitability has been issued under NZS 4431 |

Test pits are usually dug by an excavator. During digging, the sides of the excavations must be supported so the pit can be entered safely to take samples. On completion of soil sampling, backfill the test pit by compacting the material in layers so that future work in the area will not be affected. This risk can be minimised if test pits can be dug outside the line of where foundations are likely to be placed.

6.8 Landslides, slumps and erosion

Landslides, slumps, and soil erosion can undermine a building structure. The risk is likely to be high where the site:

- Has been substantially altered through earthworks or removal of vegetation
- Has a river or beach frontage
- Is at the top of a cliff
- Is on a fault line
- Is sloping and in a high rainfall area where the soil readily becomes saturated
- Has had mining activity in the past
- Is in a geothermally active area.

Visual signs of potential slipping or slumping include:

- Soil cracking parallel to the top of a bank
- A hump in the soil at the base of the bank
- Where power poles, trees or fence posts are on a lean
- A hollow in the centre of a flat area of ground
- An undercut bank
- A bank cut steeper than the angle of repose for the soil type.

In some parts of the country, expansive clays may also pose a risk to the stability of the building as the clays will shrink and swell between wet and dry parts of the year.

6.9 Gathering information

Observe the site for visual signs of past or potential landslides, slumps or erosion. Talk to neighbours who may be able to provide information about the history of the site regarding slips or soil erosion.

The local council should have information on past landslides, slumps and soil erosion within its boundaries. Aerial photos can give an indication of areas that may be at risk from slipping or soil erosion.

A LIM may contain information about slips and soil erosion.

Consider the potential impact of slips or slumps on stormwater, sewer and effluent systems. There is provision under section 72 of the Building Act 2004 for the council to refuse to grant a building consent if the land is at risk of a natural hazard, such as erosion, flooding, subsidence or slippage, or if the building work itself is likely to accelerate the problem.

References

Ministry of Business, Innovation and Employment (MBIE) - Smarter Homes

Landforms and Waterways

www.smarterhomes.org.nz/siting-landscaping/landforms-waterways/

Climate

www.smarterhomes.org.nz/siting-landscaping/climate/

Hazards

www.smarterhomes.org.nz/siting-landscaping/hazards/

Building Research Association of New Zealand (BRANZ) - Build Magazine

Storm-damaged Roofs (1 April 2011, *Build* 123)

www.buildmagazine.org.nz/articles/show/storm-damaged-roofs/

Wind Zones and NZS 3604 (1 February 2012, *Build* 128)

www.buildmagazine.org.nz/articles/show/wind-zones-and-nzs-3604/

Wind Pressure 101 (1 October 2009, *Build* 114)

www.buildmagazine.org.nz/articles/show/wind-pressure-101/

Snow Loading (1 June 2011, *Build* 124)

www.buildmagazine.org.nz/articles/show/snow-loading/

Resilient Building Design (1 April 2014, *Build* 141)

www.buildmagazine.org.nz/articles/show/resilient-building-design/

BRANZ Website

www.branz.co.nz

New Zealand Geotechnical Society

Field Description of Soil and Rock - Guideline for the Field Classification and Description of Soil and Rock for Engineering Purposes

www.nzgs.org/Publications/Guidelines/soil_and_rock.pdf

Chapter 7

Building Structure

1. Structural Design Principles

This chapter is intended to give readers with an interest in dairy housing, but who do not have a civil or structural engineering background, an insight into the relevant key structural design principles and practices that need to be considered when designing and constructing such structures. The technical information provided is therefore intentionally limited and in some subject areas is simplistic in content.

Rural practitioners should not take reliance on what is written in this chapter, but if engaged by a farm-owner to manage the design or construction of a new facility or make alterations to an existing building, should consult with a Chartered Professional Engineer with expertise in structures.

1.1 Design standards - loadings

Applicable design loadings in New Zealand are very dependent on where the structure is to be geographically located. The designer must take natural elements such as wind, snow and earthquake risk into account. These regional differences are illustrated in the maps included in the Site Selection chapter.

Loading to buildings is outlined in AS/NZS 1170 Structural Design Actions and this set of standards is used to determine design loadings to buildings and is mandatory where specific engineering design is required. It is the applicable standard for most dairy housing structural design.

Some guidance is also given in NZS 3604 Timber-framed Residential Buildings for Snow and Wind Loading, but only for light timber-framed buildings. NZS 3604, section 1.1.2 sets out the types of buildings covered by the standard. It excludes buildings that require specific engineering design (SED) and buildings without external walls.

For concrete masonry buildings, NZS 4229 Concrete Masonry Buildings Not Requiring Specific Engineering Design may be relevant but only to buildings within its stated scope. It excludes steel framed roofs and has limits on floor loading.

Table 1.1: Relevant New Zealand Structural Standards

| AS/NZS 1170 | Structural Design Actions |
|-------------|--|
| Part 0 | General principles |
| Part 1 | Permanent, imposed and other actions |
| Part 2 | Wind actions |
| Part 3 | Snow and ice actions |
| Part 5 | Earthquake actions - New Zealand |
| NZS 3603 | Timber Structures Standard |
| NZS 3604 | Timber Framed Buildings |
| NZS 3605 | Timber piles and poles for use in building |
| NZS 4229 | Concrete masonry buildings not requiring specific engineering design |

All relevant design standards can be purchased through Standards New Zealand from their website www.standards.co.nz

1.2 Limit states

The intended future performance of a structure to resist loads is characterised by two essential design scenarios: Serviceability Limit State and Ultimate Limit State.

1.2.1 Serviceability Limit State (SLS)

SLS involves making sure that the structure is still usable after an event that occurs regularly. For buildings, this typically means:

- Wall linings not cracked
- Windows not broken or leaking
- Floors not too elastic
- Cladding not broken.

However, dairy housing buildings typically do not have windows, the floor slabs are cast on the ground, and claddings are flexible so buildings are typically not governed by SLS cases. This means that the rafters or purlins might droop a little, the building might sway in a large wind or earthquake event, but this should not affect the ability of the building to perform as it should in providing effective shelter for animals.

1.2.2 Ultimate Limit State (ULS)

ULS involves a building's ability to remain stable or its main structural elements not exceeding their capacity. This means that during a large storm the main elements including roof cladding should not fail and the building should not collapse or uplift.

It is worth noting that structural engineers design for a rare event but that rare events do occur. Provisions in the loadings and materials standards mean that even during a very rare event the building should not collapse.

Because farm buildings are designed for ULS rather than SLS, the structure is typically functional rather than aesthetic. If appearance is important then this should be discussed with the structural designer.

1.3 Importance Levels (IL)

As the name implies, this is about how important the building is. It is important for high value buildings such as hospitals (IL=4) and airports (IL=3) to be functional after a large earthquake or storm, so these are designed to resist higher loads than normal buildings such as family homes (IL=2). Farm buildings (IL=1) are characterised as having a lower importance than normal buildings. This is because they are seldom occupied by people and are typically not close to other buildings, so their collapse is unlikely to damage other buildings.

For larger farm structures with a capital value of more than double that of a house, an IPENZ opinion is that the IL could go up to IL=2 requiring a more resilient design.

1.4 Specified Intended Life

The Building Act 2004, section 113(3) states that the Specified Intended Life is "the period of time, as stated in an application for a building consent or in the consent itself, for which the building is proposed to be used for its intended use". While this is usually 50 years, a longer or shorter period can be applied for to the Building Consent Authority (BCA) at the time of consent application.

1.5 Design working life

The design working life is a reference time period in years. It is a concept used to select the likelihood of different actions being exceeded, for example wind speed being higher than a certain value. This does not mean that when the design working life is reached the structure will fail; nor does it mean that it has to correspond exactly with the intended useful life the designer has in mind or with the durability of the construction materials.

2. Structural Form

There is a range of structural forms that can carry loads to their supports as illustrated in Figure 2.1. These include beams, trusses, portals and arches, all of which could be used in a dairy housing structure. Furthermore, there are a variety of materials that structures can be built from. Timber and steel are typically the most common, although concrete and aluminium elements can be incorporated.

A primary system such as a portal frame will typically support a secondary system of beams or purlins to which roof and wall cladding is attached. Lateral loads such as those experienced from wind or earthquake will determine bracing requirements, and may affect the spacing of columns in walls or the size of portal frame members.

Figure 2.1: Typical Structural Forms

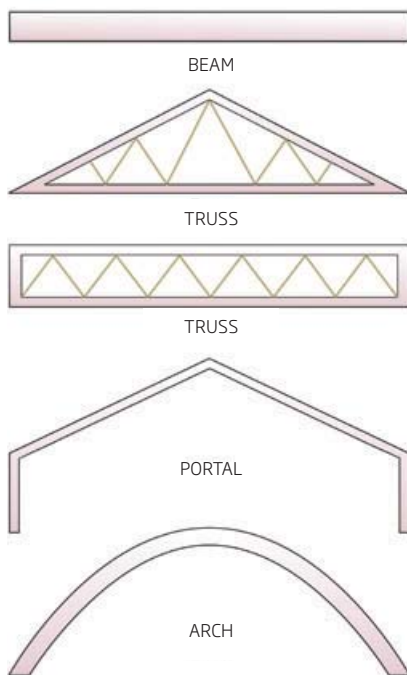

2.1 Beams

Beams are the basic elements that support building roofs. Purlins, rafters, lintels, joists and bearers are all types of beams.

Beams must be strong enough to carry loads safely, and be stiff enough to prevent sagging or excessive movement. Typical rough sawn beam sizes are 150 x 50, 200 x 50, 250 x 50 and 300 x 50 millimetres.

The most economic cross section for a rectangular beam is deep and slender because it has more strength and stiffness at lower cost than a shallow wide beam. However, if beams become too deep and slender they can become unstable. The calculations which predict buckling in this instance are not trivial.

2.2 Columns

Columns are used to support roof and floor elements such as beams, arches and trusses, and to transfer the loads from these members down to foundations. The most efficient cross section shapes for a solid freestanding timber column are circular and square. Columns of other shapes are more likely to buckle under high axial loads. However, for portal frames the supporting side frame action rather than axial loads is the governing consideration. The terms posts, columns, and stanchions are used interchangeably in the industry.

2.3 Post and beam

The simplest arrangement of beams and columns to resist vertical load is post-and beam construction (as shown in Figure 2.2) where joists or rafters bear on beams, which in turn rest squarely on top of posts. To remain in their positions, sufficient connection is required. This can be provided by steel plates nailed or bolted to beams and columns for timber members, or bolted or welded for steel members.

Figure 2.2: Post and Beam Construction

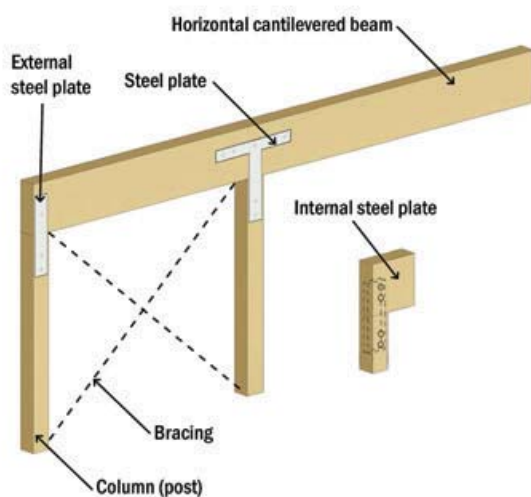

Bracing must also be provided to the framework to ensure posts remain upright and the beams horizontal. Diagonal braces or sheet cladding can be used.

2.4 Cantilever construction

A cantilever is a beam anchored at only one end. The beam carries the load back to the support. Horizontal cantilever construction allows for overhanging structures without external bracing.

For agricultural buildings vertical cantilevers are the most common use of cantilever construction where poles are embedded into the ground.

2.5 Bracing

Bracing is required to resist the non-vertical forces on framed structures, including from wind actions. Wind produces a lateral load which needs to be transferred through the structure to the foundation. Simplistically, all wind and other forces must be able to be effectively transferred down through the roof, braced walls and other framework to the floor or ground, otherwise the building structure may horizontally deflect beyond what it was designed for. Framing that is structurally connected to a concrete floor can assist by forming a horizontal diaphragm.

3. Building Frame Considerations

3.1 Open side flexibility

Cross bracing will be required in portal framed structures, typically in the longitudinal direction on the sides between the portal frames. This can limit the ability to have uninterrupted openings through the cross-braced bays, although it does mean that large clear openings can be achieved, say for ventilation.

Conversely, cantilever structures have limited spans but the cantilevers provide support transversely in both directions so cross bracing might not always be needed. This is similarly true for both timber and steel framed structures.

3.2 Buildability

Portal frame structures have more construction tolerance than cantilever structures.

When setting up foundations for a structure, columns are often set into the top of piles. Piling is a foundation system that has greater positional tolerances but getting columns placed very accurately can be difficult. When setting the piles into foundations, a slight lean off vertical at the base can make a big difference at the top of the pole. For example, if a 4-metre high pole is out by one degree at its base, it will be 70 millimetres out at its top. Therefore for cantilever construction, a clear specification and experienced contractor are important.

Portal frame foundations are usually connected to the columns using mechanical or chemical anchors. These can be installed after the foundations are poured so tolerances on pouring are not required to be as tight.

3.3 Modifying existing building

Dairy housing buildings are typically designed with minimal structure so there is usually very little scope to remove columns whether they are timber or steel, without adding in other members to compensate.

However, for wall structures or portal framed structures, it is possible to relocate walls along a line or relocate cross bracing to form an opening. This may require an assessment of foundations. It may also require a building consent, so, it might be necessary to check with the local BCA or a Chartered Professional Engineer with expertise in structures.

3.4 Extending existing buildings

Most structures can be added onto. As illustrated in Figure 3.1, making them longer rather than wider is typically easier because:

- If widening, existing columns along the common side are required to support more roof. Given that these buildings are designed with little redundancy, these columns will likely require strengthening (or doubling) and upgrading to their foundations.
- Widening can create the need for an internal gutter. Such gutters need to be maintained and are more susceptible to blockage. The exception is a mono-pitched cantilevered structure, which can be widened without the need for internal guttering.

Regardless of which type of framing material used, if there is an intention to extend the structure later, then this needs to be discussed with the designer so future proofing can be built into the initial design.

Figure 3.1(a): Mono-pitched (with extension options)

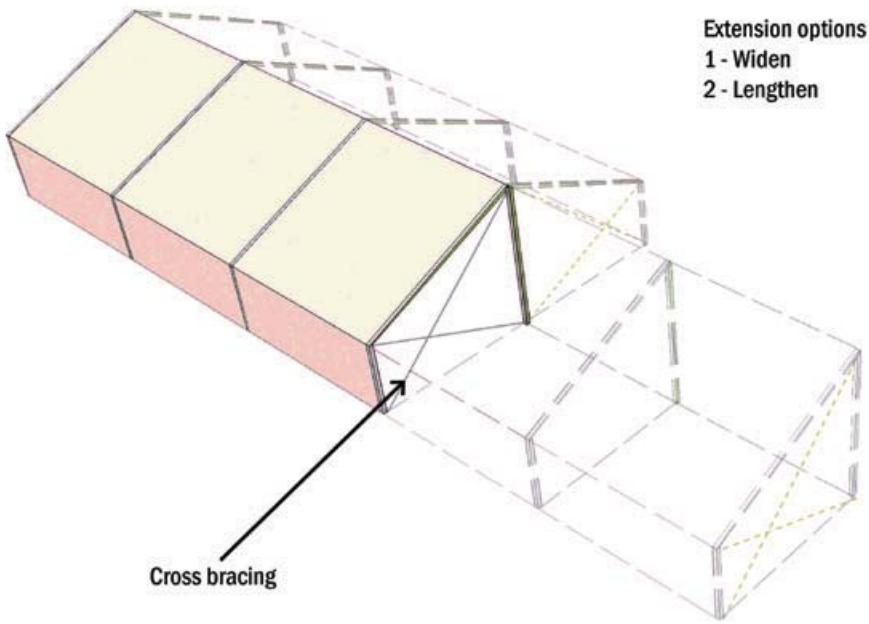
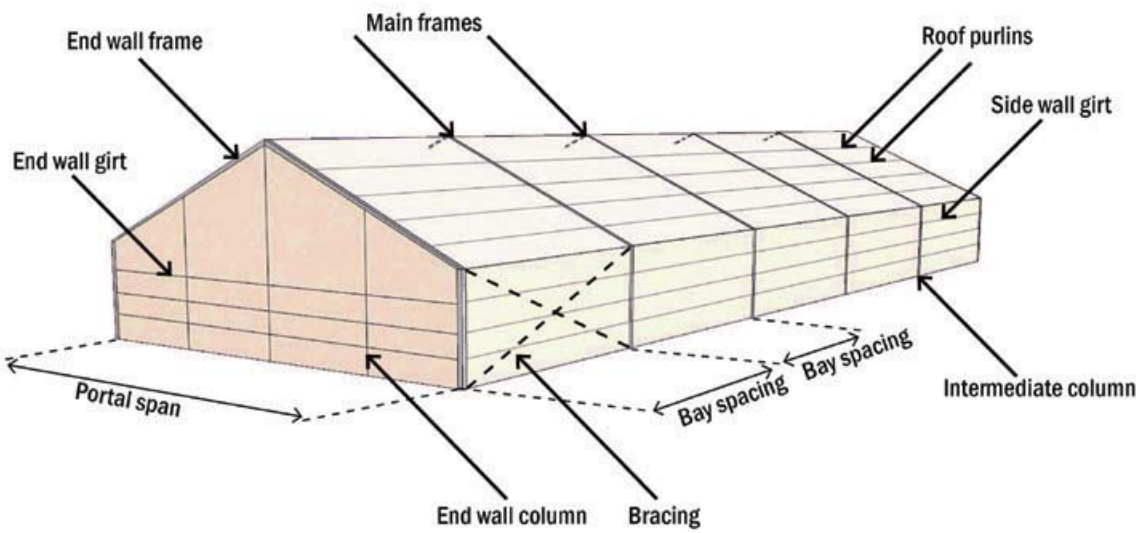

Figure 3.1(b): Portal Frame Construction



4. Timber or Steel Structure?

Timber and steel frame structures are common choices for agricultural buildings because they are lower in cost, easier to work with, and rural building contractors are familiar with them.

Concrete structures are less common for agricultural buildings and more often used in warehouse and commercial building walls because they provide for fire rating. This rating is not an issue for rural structures as farm buildings are usually some distance from boundaries and neighbouring buildings.

Concrete is typically too heavy and expensive to use in a dairy housing roof structure but is used in wall panels. Commentary on timber and steel frame structure options is made in Tables 4.1 and 4.2.

Table 4.1: Timber Frame Options

| Timber Frame Options |
|--|
| <p>Simple timber frame structures</p> <p>For smaller buildings, this frame type uses timber columns, rafters, and bracing. Timber sections may be whole, formed from smaller sections using nails or bolts, or laminated with special glues. This option often incorporates internal columns that can support pens.</p> |
| <p>Timber portal frame structures</p> <p>For larger buildings with clear spans this frame type normally requires deep composite timber columns with knee and apex bracing, and deep composite rafters. These are usually formed either from plywood with added sawn timber sections, or from laminated glued units. Steel columns and knee braces may also be combined with timber composite rafters and apex braces.</p> |
| <p>Timber pole cantilever structures</p> <p>Clear span distance is limited by the pole strength. Once spans become too large (greater than about 19 metres), a portal frame type structure is usually more structurally efficient.</p> |



Timber pole structure

Table 4.2: Steel Frame Options

| Steel Frame Options |
|---|
| <p>Concrete panel/steel roof</p> <p>Panels, often made of concrete, are placed and connected side-by-side around the building perimeter. These panels if solid, or with columns attached, can support a steel roof system.</p> |
| <p>Portal frames</p> <p>This is a single-span frame of columns and rafters sometimes strengthened by knee and apex braces, and by beams and bracing between the frames. These are popular as they provide unrestricted span and maximum flexibility of use.</p> |
| <p>Cantilever poles</p> <p>Similar in concept to cantilever timber structures but the steel poles are able to provide a greater beam span distance. However, they are not able to span as far as portal framed structures.</p> |
| <p>Arched (Hooped or Curved)</p> <p>An efficient structural form for carrying uniform vertical loads, this option can be more economic than traditional wood and steel structures. They can be installed directly on the ground, or on concrete or wooden walls to improve headroom.</p> |



Portal frame steel design (with support fly braces)



Arched steel frame design

4.1 Durability

Timber and steel can be expected to last for at least 50 years (but with some maintenance) provided they are installed to good practice design. Given the comparatively short commercial life span of these structures, durability is often not a major factor in deciding which material to use. Nevertheless, the location and intended use may be a deciding factor when choosing either a timber or steel structure.

For example, in coastal locations, provided the fixings have appropriate corrosion protection, timber may provide lower maintenance and therefore be a more durable option.

However, animal urine/manure, and some stock feeds, can severely attack any steelwork they have contact with. Galvanised coatings alone may not provide sufficient long-term corrosion protection. The highest corrosion attack zone is near floor level, and in animal traffic areas. Where possible structural elements should be placed clear of these aggressive zones, encased in concrete, or alternatively have a heavy protective coating of polyurethane or similar applied. Hollow steel sections require particular attention at ground level.

Additionally, timber structural elements need to be protected from being chewed by cows.

4.2 Maintenance

Because of the corrosive atmosphere of some types of dairy housing, and especially at floor level with its wet acidic environment, steel framing is likely to require more ongoing maintenance than similar timber structures. Nevertheless, even timber structures will likely have steel fixings and these will need to be maintained, checked and possibly replaced during the building's life. The timing for programmed maintenance will depend on a variety of factors including the hours per day or year of use, climatic conditions and geographical location.

4.3 Cost

The difference in cost between timber and steel is usually most related to a combination of the following factors:

- Remoteness of site
- Local builder availability and their preferred construction techniques
- Prefabrication availability
- Source and quality of materials.

Getting comparative prices from several acceptable and experienced suppliers to install at the intended site is recommended.

4.4 Bird perch and nesting

Birds are a hygiene risk in a dairy barn so methods of eliminating both perching and nesting need to be considered. The cross section shape design of both timber and steel used in roof rafters and purlins should minimise potential locations for bird nesting and perching. Figure 4.1 illustrates a progression from high to zero for bird perch and nesting risk.

Figure 4.1: Steel Section Options

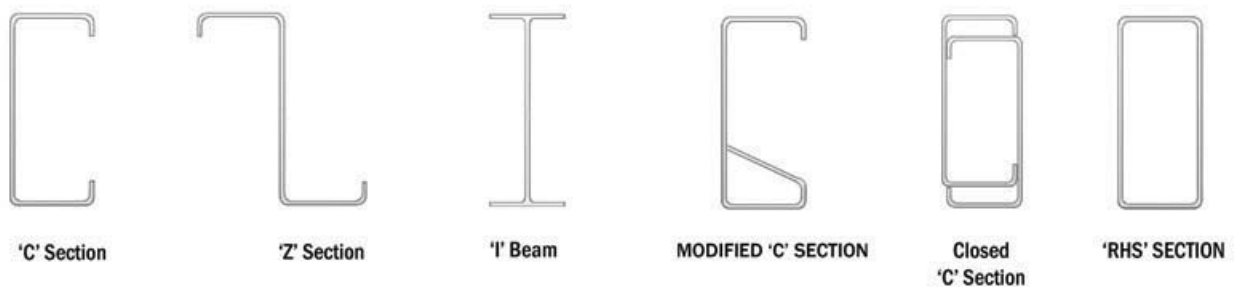

Regardless of the section chosen, if roof purlins are placed across the top of roof rafters the openings created under the roofing material can provide nesting areas. Fitting flashings over open sections or installing upward facing wire spikes are options to reduce this risk.

4.5 Foundations

Due to the lightweight nature of the buildings, the foundations beneath columns are designed to resist seismic and wind uplift. As such, both timber and steel structures will likely require similar foundations on any given site.

4.6 Organic certification

Some organic certifiers do not allow treated timber to be installed on farms. This is something worth checking if the farm is planning for certification or currently holds certification.

5. Fixings and Connections

When choosing the most appropriate method of joining or fixing pieces of timber, the quality of the joint and requirements for strength must be considered. In windy and exposed areas of New Zealand, well designed roof connection detailing is critical.

Methods of jointing or fixing include nails, screws, bolts and connector plates. The level of galvanising or opting for stainless steel fixings should also be considered.

5.1 Nails

Nailing is by far the most common method used for joining and fixing of timber and many different types of nails exist for specific uses.

Nails have a tendency to split timber when being driven. The use of blunt or chisel pointed nails may alleviate the problem, as well as predrilling of kiln-dried timber. The metal in some nails can react with the extracts from timbers, forming stains. For instance, uncoated steel nails can cause black stains while copper nails leave green stains. Staining can be avoided by using galvanised nails, however, stainless steel nails or other fasteners are required when they are in contact with timber treated with particular preservatives such as, copper azole (CuAz) and ammoniacal/alkaline copper quaternary (ACQ).

5.2 Screws

Screws are commonly classified by head type and by the method of drive. They are mainly used for light to medium scale structural situations and offer superior pull out strength for wind resistance situations compared to nails. For example, "Tek" screws drill their own hole and then tap threads to combine two or more material types.

Screws are available as uncoated (bright), zinc plated, hot dip galvanised or in stainless steel. The latter should be used for particularly corrosive environments. A number of head styles are available for different applications and material types.

5.3 Bolts





For timber post and beam connections hot dipped galvanised (HDG) bolts are the most common fixing type for farm structures. Stainless steel (SS) bolts are also used where there is a need for corrosion resistance. Bolts function by bearing on the surface of the timber and shearing action within the bolt itself. In all instances, bolts should be accompanied with washers.

Bolts are commonly used to fix large timber members together, or timber to steel. Coach screws are used for slightly lower strength situations and are essentially heavy-duty screws but are sized similar to bolts. They are useful where nuts cannot be placed onto bolts and are only suitable for timber-to-timber joints, or steel to timber joints.

Bolts can also be used to attach timber to concrete or masonry. This is typically with special masonry or chemical anchors. In these instances, no nuts are used on the end in the concrete or masonry. Instead, the bolts rely on friction or adhesion to the substrate. Care is required to make sure the anchor strength is sufficient to resist pull out loads. In addition, washers at the bolt heads must be large enough to prevent timber fibres from crushing when exposed to pull-out loads.

Figure 5.1 illustrates the various types of bolts and their applications.

Figure 5.1: Bolts - Types and Applications

| | | |
|--------------------------|--|--|
| Hexagon head bolt | General structure purposes |  |
| Cup head bolt | Occasional structural purposes where the head must be flush with surface |  |
| Coach screw | Used to replace bolts where the nut is inaccessible or to improve appearance |  |
| Threaded bolt | Applications where it is difficult to specify bolt length beforehand, eg tie-down rods, pole construction and cross-bracing |  |

5.4 Connector plates

Connector plates grip timber pieces securely and aid in the transfer of forces across timber joints. Connectors are manufactured by stamping machines that punch out the plate teeth, setting them at right angles to the plate.

The use of preformed metal plate connectors offer a very stable and practical alternative to nailing. As is the case for all mechanical fixing methods, resistance to withdrawal must be considered, as should joint strength and the fixing placement to avoid splitting.

Corrosion is more severe in confined, moist environments (such as dairy sheds and where cows are housed) than in outdoor environments subject to continual washing by rain. Connector plates should not be exposed to the weather because repeated wetting and drying can cause tooth withdrawal due to shrinkage and swelling. In general, galvanised connector plates are the preferred finish. However, when used in moist tanalised timber in a corrosive environment, stainless steel plates, or other forms of connection can be better options.

5.5 Galvanised fasteners

As a minimum level of corrosion protection, hot dipped galvanised bolts and other fasteners should be used for agricultural applications and high corrosion environments. Hot dipped galvanising involves the application of a relatively thick sacrificial zinc coating by immersion in a bath of molten zinc. The process leaves a rough surface with enhanced withdrawal and corrosion resistance characteristics.

Although more expensive, stainless steel fasteners provide the best corrosion protection option and need to be considered for harsher environments.

Harsh weather exposure and atmosphere conditions combined with chemicals in treated timber can lead to electrolytic cells forming in the timber structure. Thus, where the treated timber moisture content increases, corrosive conditions can occur. This is especially relevant in a coastal environment where airborne salt spray represents a severe corrosion hazard to metal fittings.

5.6 Structural connections

An efficient connection maximises structural performance and minimises cost and installation effort. For example, many small connectors spaced closely together, such as nails, can be more efficient than fewer large connectors spaced further apart, such as bolts. In addition, nails have the added benefit of being fast to install, especially when used with a nail gun and nailing template. Design rules for bolts, screws and nails are given in NZS 3603, but more recent work has shown these are sometimes not as conservative as previously thought.

Design of the timber joint can also enhance connector efficiency. For instance, beams that provide bearing directly onto columns are better than cleat joints. If a cleat joint cannot be entirely avoided, then using a corbel to support the beam is preferable as illustrated in Figure 5.2.

Figure 5.2: Connection of Timber Beam to Column

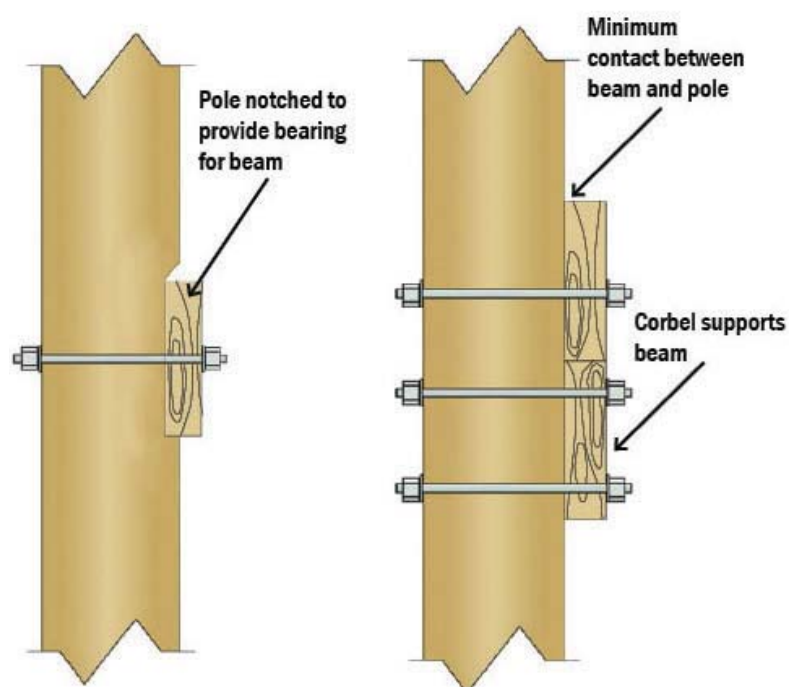

Timber selected for structural applications must be able to provide strong joints as well as strong spanning ability. This is determined by strength developed parallel or perpendicular to the grain. If one direction is weaker than the other then joint strength is reduced. Splitting may occur if connectors are placed too close to the edge or too close to each other. Minimum end and edge distances are given in NZS 3603 and 3604.

For timber framed buildings designed to NZS 3604, earthquake bracing demand must make allowance for the zone in which the structure is to be built.

In all but the simplest of timber and steel structures, a Chartered Professional Engineer must be engaged during design to ensure Building Code compliance.

5.7 Column foundation detail

The base of the column (poles) where it interfaces with the concrete foundation can be a common location for deterioration of a critical part of a building's structure from:

- Column movement
- Damage from cows and mechanical equipment
- Dairy effluent ponding in this area with some long term acid attack on the concrete and the column.

However, some limited effects from these may be acceptable to the farm owner following consideration of relevant factors, including those in Table 5.1.

Table 5.1: Column base design considerations

| | |
|--------------------------------------|---|
| Timber grading | Consider rough sawn and H5 timber treatment |
| Intended life of the facility | Short or long term, for example 10 years versus 50 years Note that the Building Code durability life must also be satisfied and this may be longer than the intended life. |
| Maintenance regime | Minimal maintenance or annual checks including full wash down |
| Risk of damage profile | Operational importance of having uninterrupted use of the facility in the event of an extreme event, for example wind storm or snow |
| Intended use of the structure | Intensive use or occasional use |
| Budget | Lower cost verses robustness with a "higher" specification |

At the base of cast-in cantilever columns, friction between the concrete foundation and a timber pole or steel column, by itself, can be insufficient to resist some vertical movement from wind (or possibly seismic) uplift over the intended life of the building.

A solution is the installation of horizontal reinforcing bars that connect the column to the concrete foundation and in turn provide pull out resistance as shown in Figure 5.3. Providing some fall (change in gradient) in the foundation, even if it is minimal, to prevent effluent ponding around the base of poles and columns is essential.

5.7.1 Timber poles

Timber poles are usually installed 'wet' and over time they can shrink leaving a gap between the concrete and the pole which can be exacerbated by constant wetting and drying during service life. Uplift capacity can also be compromised if poles are incorrectly inserted small end diameter first into the foundation hole. Contaminants can fill any gap created around the pole and attack the timber and concrete connection, especially if the poles are not timber treated to the necessary hazard level. Poorly placed and low strength concretes around poles are less resistant to column movement.

Figures 5.3 and 5.4 illustrate good design practice.

Figure 5.3: Timber Pole Base Detail

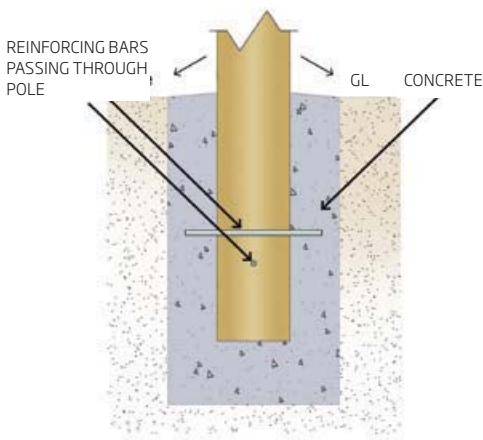
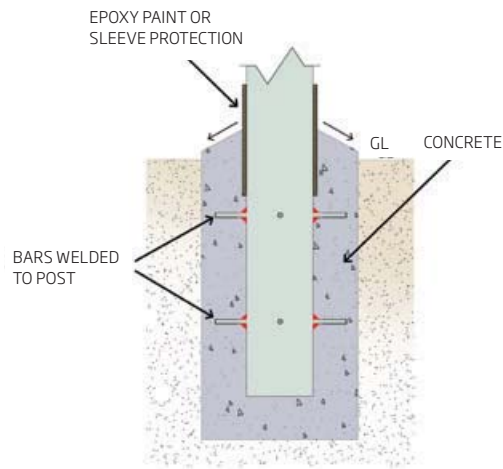

Figure 5.4: Steel Column Hollow Section Pole Base Detail



Note: these are suggested details only. Foundations should always be constructed to the structural engineers design requirements and as detailed on their drawings.

5.7.2 Steel columns

Steel columns can be more problematic at the floor surface interface than timber. Some potential issues can be reduced with applying either a layer of non-conductive high build epoxy paint, or rubber sleeving to provide corrosion protection. The choice will depend on potential harm to cows if they are in direct contact with columns.

Hollow sections need drainage holes above the sleeve, with substantial internal protection below the holes.

5.8 Resilient building design

A vital component of a resilient business is having a functional building that continues to function after a major event, such as an earthquake or high wind event. Table 5.2 details some mitigation options in resilient building design for seismic events.

Table 5.2: Resilient Building Design

| Building Design - Seismic Mitigation | |
|--|---|
| Reduce wWeight | It is desirable to reduce weight when designing a building. Besides seismic vulnerability, extra weight (such as from mezzanine floors) also results in larger foundations and higher construction costs. While seismic weight can be compensated for with more structure, this usually adds building costs for equivalent building resilience. |
| Keep heavy items low | Heavy items, such as plant and equipment, should be placed as low as possible in the building structure |
| Ductile connections | Floor slabs need to be connected to walls. Frequently, the steel connection itself is quite robust, but the connection to the substrate can be friable or brittle. Examples of damage resulting from non-ductile connections are splitting of timber members at fasteners such as bolts, and pull-out of bolts and fixings cast into concrete. Allow for movement caused by the effects of temperature and shrinkage. |
| For further details see <i>Resilient Building Design</i> (1 April 2014, <i>BRANZ Build 141</i>) | |

6. Timber

Table 6.1: Relevant New Zealand Timber Standards

| Standard | Detail |
|----------------|--|
| NZS 3602:2003 | Timber and wood-based products for use in building |
| NZS 3603:1993 | Timber structures standard |
| NZS 3604: 2011 | Timber-framed buildings |
| NZS 3605:2001 | Timber piles and poles for use in building |
| NZS 3640:2003 | Chemical preservation of round and sawn timber |

6.1 Timber treatment

NZS 3640 Chemical preservation of round and sawn timber, sets out the preservative treatment and identification of timber to provide protection from insect attack and decay. This is based on six hazard classes, H1 to H6. Table 6.2 lists recommended timber treatment levels.

Table 6.2: Treatment Levels for Different Uses in Timber Framed Buildings (Radiata Pine and Douglas Fir).
Adapted from *BRANZ Build 128*.

| External timber use | | Clear of ground use | |
|---------------------------------|----------------------------|---|----------------------------|
| Timber to be used for: | Minimum required treatment | Timber to be used for: | Minimum required treatment |
| Exposed subfloor framing | H3.2 | Exterior plywood unpainted or used as bracing | H3 CCA |
| Posts supported clear of ground | H3.2 | Joist/bearers | H3.2 |
| Piles | H5 | Roof framing weather exposed | H3.2 |
| Poles | H5 | Wall framing weather exposed | H3.2 |

For most agricultural activities, such as use in dairy barns where timber is in contact with farm dairy effluent, H5, or a higher level than the minimum BRANZ treatment level, is recommended.

NZS 3640 requires treated timber to be clearly branded (as shown in Figure 6.1) with the:

- Treatment plant identification number
- Treatment type (preservative code)
- Treatment level (hazard class)
- Mark of quality assurance provider (optional).

Figure 6.1: Treated Timber Branding
Adapted from Figure 1 *BRANZ Build 128*)

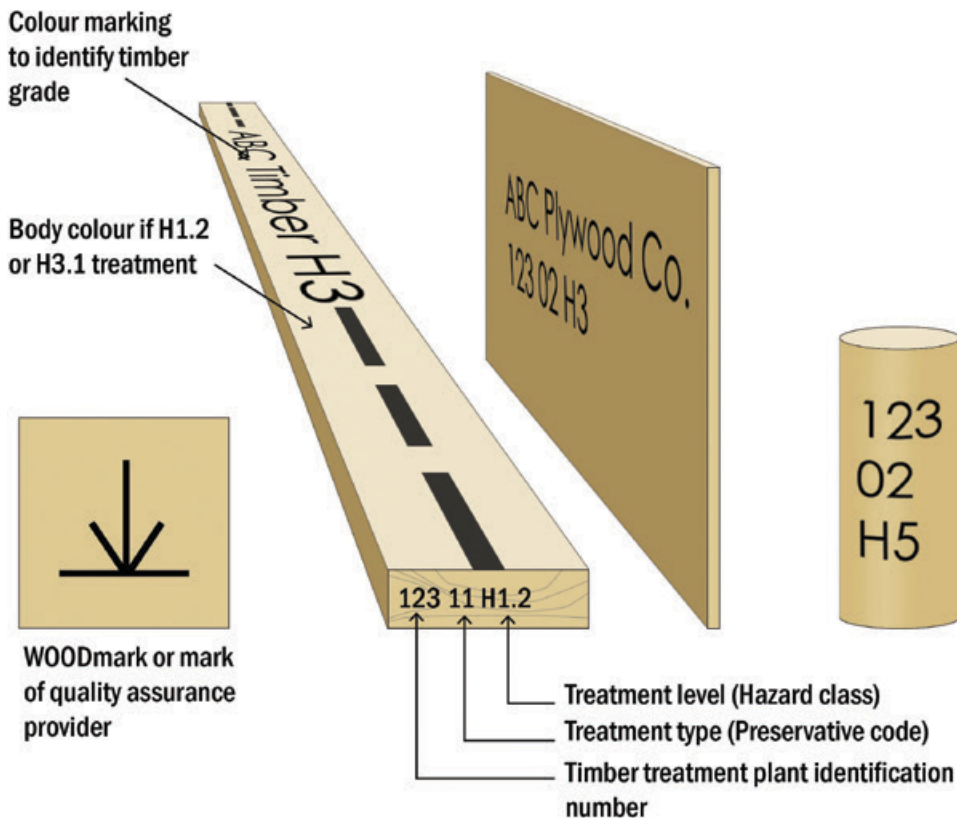

Note:

1. Timber may be identified by a brand running along the length
2. Timber grade colour marking should not be confused with MSG colour branding
3. On delivery, check timber for grade and treatment against that specified. Store timber of different grades and treatment separately

The use of off-site fabrication increases the difficulty in identifying timber treatment types on site. Designers, specifiers and anyone supervising construction should insist that suppliers of all timber components arriving on site provide certification of the treatment used.

Having construction monitoring staff on site that are working directly with the designer(s) will assist in reducing such issues.

7. Steel

7.1 Introduction

When opting for steel components in a structure such as cladding, beams, columns, rafters, purlins and fasteners, the designer should consider some important steel selection issues as commented on in Table 7.1.

Table 7.1: Steel Selection Issues

| Steel Issue | Comment |
|---|---|
| Site environment | <ul style="list-style-type: none"> Steel corrosion rates vary around New Zealand depending on location (see NZS 3604 section 4, and NZS 3404.1 for steel-specific guidance). |
| Grade and type of steel proposed | <ul style="list-style-type: none"> For example, specify the correct grade of stainless steel to provide sufficient durability for the environment it is to be used in. |
| Size and type of steel components | <ul style="list-style-type: none"> Steel size and type can influence the amount of galvanising zinc deposited onto the steel surface (see AS/NZS 4680). |
| Compatibility of steel components with adjacent materials | <ul style="list-style-type: none"> Some timber treatments are corrosive to steel Avoid galvanic corrosion risk from incompatible metals. |
| Will components be fabricated before hot-dip galvanising? | <ul style="list-style-type: none"> Site treatment of welds are often not as durable as hot dipping the whole component. <p><i>(Note: certain types of painting systems applied after welding can provide similar or better corrosion protection than before welding.)</i></p> |
| Corrosion protection | <ul style="list-style-type: none"> Where possible, place steel columns in “dry zones” Apply specific protective coatings to extend building life. |
| Future inspection and maintenance | <ul style="list-style-type: none"> A building maintenance plan should be developed How are building components that will require early replacement going to be accessed (as required Building Code clause B2 durability)? How are surfaces requiring cleaning and painting going to be assessed? |
| Imported steel fabricated products | <ul style="list-style-type: none"> Do they meet New Zealand specifications and standards? |

Table 7.2: Relevant Steel Related Standards

| Standard | Detail |
|-------------|---|
| AS/NZS 1163 | Cold-formed steel hollow sections |
| AS/NZS 1554 | Structural Steel Welding |
| AS/NZS 2980 | Qualification of welders for fusion welding of steels |
| AS/NZS 4680 | Hot-dip galvanised (zinc) coatings on fabricated ferrous articles |
| NZS 3404.1 | Steel Structures Standard - Materials, fabrication and construction |

7.2 Steel selection

7.2.1 Metal compatibility

Contact with zinc or aluminium will result in the deterioration of austenitic stainless steels. Furthermore, lead is not compatible with zinc or aluminium coated products. Copper is not compatible with mild steel, galvanised steel, zinc/aluminium coated steel, or pre-painted roofing steel. Even when two incompatible metals are not in direct contact, it is still possible for metals to be damaged through liquid contact, for example water run-off from copper to aluminium or zinc should be avoided.

Designers should specify only one material in a construction, or choose metal combinations in which the constituents are as close as possible in the corresponding galvanic series. To eliminate this risk, a transition piece between the metals is often used.

7.2.2 Steel and timber combinations

In some situations, such as where steel beams support timber members treated with copper-based treatment chemicals, damp timber will be more corrosive to steel.

Depending on the situation, the steel should include some of the following protection measures:

- Be hot-dip galvanised after manufacture - all cleats and the like are attached to the member before it is galvanised
- Have a specialist anti-corrosive coating system applied to the galvanised steel
- Use an isolating layer, such as a damp proof course (DPC), between the steel and the timber when in close contact
- Be fixed to the timber with 304 stainless steel bolts and washers
- Have the bolts sleeved where they pass through the timber
- Be checked annually for any deterioration.

Figure 7.1 illustrates a good practice option for steel and timber connections.

Figure 7.1: Connection of Timber to Steel

(Adapted from Figure 1: Durability and exposed steel beams, *BRANZ Build 126*)

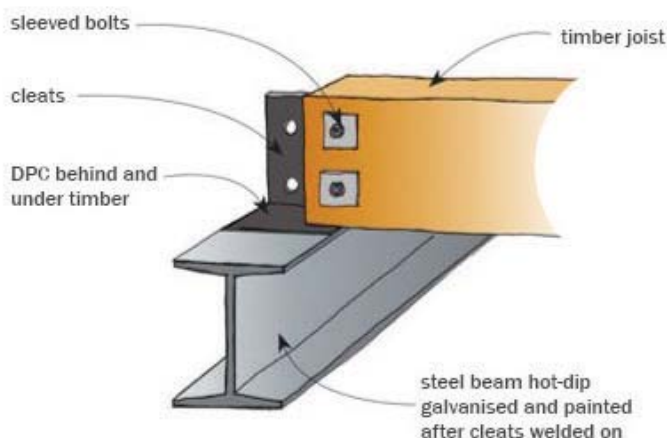

7.2.3 Galvanic corrosion

The potential for galvanic corrosion needs to be considered in all structures containing metal components. Galvanic corrosion is the deterioration due to contact between dissimilar metals. This type of corrosion is commonly seen when two metals are in electrical contact while moisture (or any conducting corrosive electrolyte) is present. There can be aggressive corrosion of one metal at the joint area, with partial or complete protection of the other metal. Figure 7.2 illustrates this process.

Water provides a path for ion transfer between the anodes (where metal is lost) and cathodes (the other surface areas) where metal oxides and hydroxides such as rust are formed. Generally the wetter and warmer, the greater the corrosion reaction rate resulting.

Figure 7.2: Galvanic Corrosion

(Adapted from Figure 1: Galvanic Corrosion, *BRANZ Build 113*)

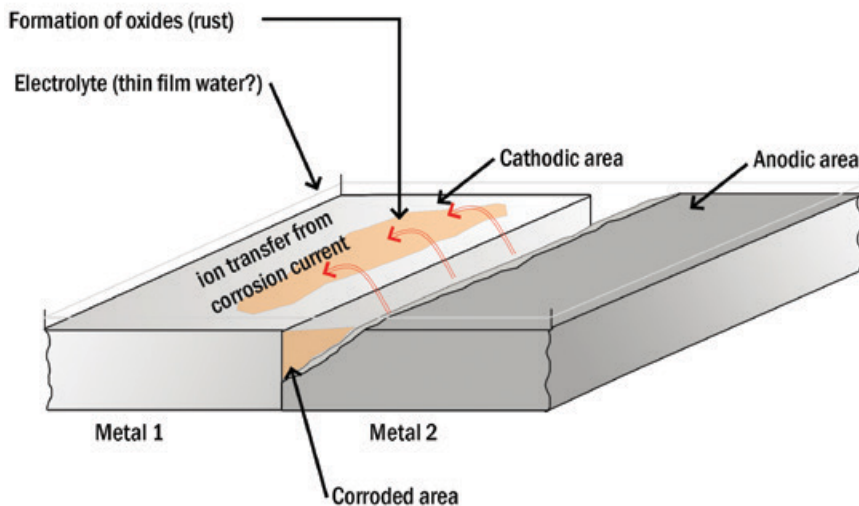

7.2.4 Stray voltages

Animals are sensitive to stray voltages that can be induced in steelwork. Design and construction practise should ensure that all steel, including reinforcing bars and mesh in concrete is electrically connected and appropriately earthed. Stray voltages are further discussed in the “Services” section of this practice note.

7.2.5 Imported steel products

Steel sections for New Zealand seismic frames need to reach yield/tensile and ductility requirements, which match specific properties corresponding to AS/NZ standards as seismic (S) grades. Currently only a few steel mills manufacture to this standard with the bulk of the sections being manufactured in Australia. The associated welding procedures have to be completed to AS/NZ welding fabrication standards and cannot be replicated without formal qualification processes.

Imported fabricated steelwork does not carry the same assurance of quality control on materials selection and fabrication as New Zealand made steelwork. New Zealand specific structural steel fabrication requirements cannot be readily picked up by the overseas competitor without substantial implementation and quality assurance efforts, which would have to include third party product conformance inspections.

Overseas manufacturers need to use complying steels and welding consumables, which they would have to import from the same sources as New Zealand fabricators as well as using the same required qualified welding fabrication procedures.

Therefore, the building owner and their advisors need to ask the steel fabricator detailed questions to ensure steel products as supplied meet all relevant New Zealand specifications and standards.

7.2.6 Welder qualification

New Zealand standards require structural steel welding, both at a fabrication workshop and onsite, and to be undertaken by a welder who meets the qualification tests as detailed in AS/NZS 2980: Qualification of welders for fusion welding of steels. This standard provide a set of technical rules for welder qualification tests, and enables such

qualifications to be uniformly accepted independently of the type of product, location and examining body. Farm-owners should check that the welders they use have such a qualification otherwise the Building Code (BC) signoff and potentially the integrity of the structure(s) may be affected.

Construction monitoring of the welding will be required, and further, IPENZ recommends that construction monitoring should be a condition of the BC.

7.3 Steel corrosion

As the life of exposed steel components is often shorter than the expected service life of the structure itself, likely maintenance and renewal requirements need to be considered at the design stage. For structures in coastal and corrosive environments, additional steelwork protection will be required to meet the BC clause B2 Durability.



Steel corrosion

Table 7.3: Relevant Corrosion and Protective Coatings Documents

| Relevant New Zealand Corrosion Related Standards | |
|---|---|
| AS/NZS 2312 | Guide to the protection of structural steel against atmospheric corrosion by the use of protective coatings Part 1: Paint coatings |
| NZS 3404.1 | Steel Structures Standard Part 1: Materials, fabrication, and construction |
| Clause B2 (Durability) of the New Zealand Building Code and Clause 5.1.1 of NZS 3404.1 provides further information | |
| Guidance Documents | |
| HERA Report R4-133:2011 | New Zealand Steelwork Corrosion and Coatings Guide |
| BRANZ Build | Various (see references section) |
| Use of materials from these documents in this section is acknowledged | |

7.3.1 Effects and rates of corrosion

Rust can form on the surface of steel as a porous, loose layer with a denser layer below adhering to the steel. Corrosion can be accelerated further by the rust itself by allowing moisture and contaminants to be held on the surface. Rust can form below paint films, especially on old or damaged coatings.

Corrosion rates vary considerably with environmental conditions, temperature and the amount of maintenance carried out. Water does not need to be in contact with the steel as corrosion can occur when the air humidity exceeds 65 per cent. Continuing high humidity can be more detrimental than occasional wetting due to the length of time moisture is in contact with the steel. When atmospheric salts such as chlorides are deposited on a steel surface, even at low relative humidity, corrosion may occur because of the increased concentration of water droplets.

The damaging effect of pollutants can be seen where steel that is washed by rain corrodes at a much lower rate than steel in positions where salts and acid can accumulate, for example, at the underside of exposed steel beams.

Higher risk corrosion zones are likely to create greater ongoing corrosion issues. An example of this is steel elements such as purlins on the underside of a roof exposed to salt air or ammonia, especially where they are not regularly washed or are not subject to washing from rainfall.

Steel surfaces are often colder than the surrounding air temperature, which causes condensation and dew to form more readily, increasing the time steel is wet.



Corrosion effects: This photo is an example of where steel corrosion has been exacerbated by poor ventilation and an inadequate coating system applied at the time of installation. The proposed remedial work involves replacing the entire roof, and vapour blasting and coating the roof trusses. To reduce the rate of corrosion in the future, a ventilation system will be installed to remove heat and chemical concentrations and reduce the effects of a hot humid climate.

7.3.2 Farm Dairy Effluent (FDE) corrosion

During fermentation of FDE, microbial bacteria can consume oxygen from metal surfaces (O_2 reduction) and take energy from the organic content of the FDE. Subsequently, microbes can convert sulphate into ferrous sulphide (FeS) which can act as cathode and parental metal as anode, thus promoting corrosion. Regular wash down of metal surfaces is important to reduce this corrosion.

Where possible, steelwork should be located away from FDE, for example, placing a steel column behind a wall in a dry zone rather than in front of the wall in a cow feeding passage.

7.4 Protective coatings

High-performance coatings can also be used to control corrosion by isolating the steel from the environment. New paint coatings can offer an effective barrier but this effect decreases with time, for example via UV exposure and physical wear and tear. Eventually the paint film ages, and breakdown and corrosion begin on the steel surface.

Rust has a much greater volume than steel. As it expands beneath the paint film, it causes blistering, cracking and flaking allowing the entry of moisture, which causes the process to accelerate.

The length of time a coating provides protection is influenced by:

- Whether the steelwork design allows salts and contaminants to accumulate
- The type of coating used
- The coating's adhesion to the steel, which is dependent on the steel surface being clean and free from loose matter
- Adhesion between successive coats in the system
- The thickness of the coating
- The applied paint system's ability to withstand the environment, including ultraviolet radiation and abrasion.

AS/NZS 2312:2002 "Guide to the protection of structural steel against atmospheric corrosion by the use of protective coatings" can be used as a guide to the correct selection of a protective paint system. Further relevant information is provided in HERA Report R4-133 and section 5 of NZS 3404.1

While the above comments are intended for structural steel they can also be relevant to certain types of steel cladding depending on how they are used in the structure.

In steel cladding there are 4 main options available in NZ:

- Zinc-Aluminium coated (both sides)
- Galvanised (both sides) - not very common
- Zinc-Aluminium coated (both sides) with multi-layer applied paint on the exposed surface and a light duty 'Service coating' of paint on the inside, for example Colorsteel®
- Zinc-Aluminium coated (both sides) with multi-layer applied paint on both sides, for example Colorsteel MAXX®. This type has maximum protection.

7.4.1 Types of coatings

Coatings for steel generally fall into three protection types.

(1) SACRIFICIAL

The most common sacrificial material used in coatings is metallic zinc. This is deposited on a steel surface as zinc metal spray or galvanizing, or as a zinc-rich priming paint.

Sacrificial systems are able to protect steel exposed in cuts and scratches. The zinc metal pigment in the layer combines with the oxygen in preference to the steel, as shown in Figure 7.3. The zinc is encased in a matrix that slows down the rate of zinc loss so enhancing the life of the coating.

Figure 7.3: Inorganic Zinc Silicate Layer Providing Sacrificial Protection to the Steel Layer.

(Adapted from *New Zealand Steelwork Corrosion and Coatings Guide*, Figure 1.2)

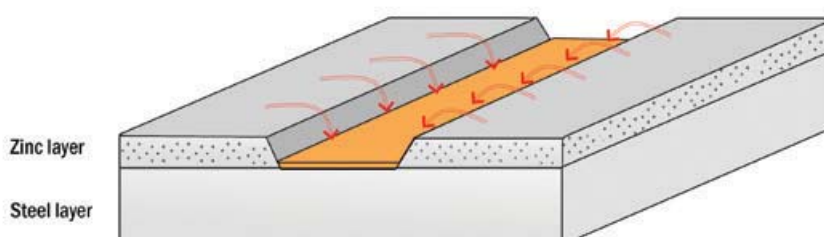

(2) PASSIVATING

Passivating systems seek to make the substrate material more passive, that is make them less affected by environmental factors such as air and water. In the primer coat, chemicals such as zinc phosphate contain passivating pigments. Pigments combine with moisture so that when it reaches the steel layer it is inhibited and slows the formation of anodes.

(3) BARRIER

Barrier coats work by both sealing the steel surface from air and water, and electrically isolating the anodic and cathodic surfaces, thus preventing the electrochemical reaction from operating.

A rust layer forms as shown in Figure 7.4 (a) leading to swelling around the damaged area and deterioration.

This risk could have been reduced if there was a sacrificial layer of galvanising between the steel and paint as shown in Figure 7.4 (b), or by using a sacrificial underlying layer of zinc-rich primer as shown in Figure 7.4 (c).

A repair for the situation shown Figure 7.4 (b) is to apply paint over the galvanising. The zinc prevents corrosion of the exposed steel and the damaged area is sealed.

A repair for a multicoat system as shown in Figure 7.4 (c) is to use a barrier coat over a zinc-rich primer sacrificial undercutting layer. This will provide some metallic zinc for undercutting protection.

Figure 7.4: Barrier Coating Systems

(Adapted from *New Zealand Steelwork Corrosion and Coatings Guide*, Figure 1.3)

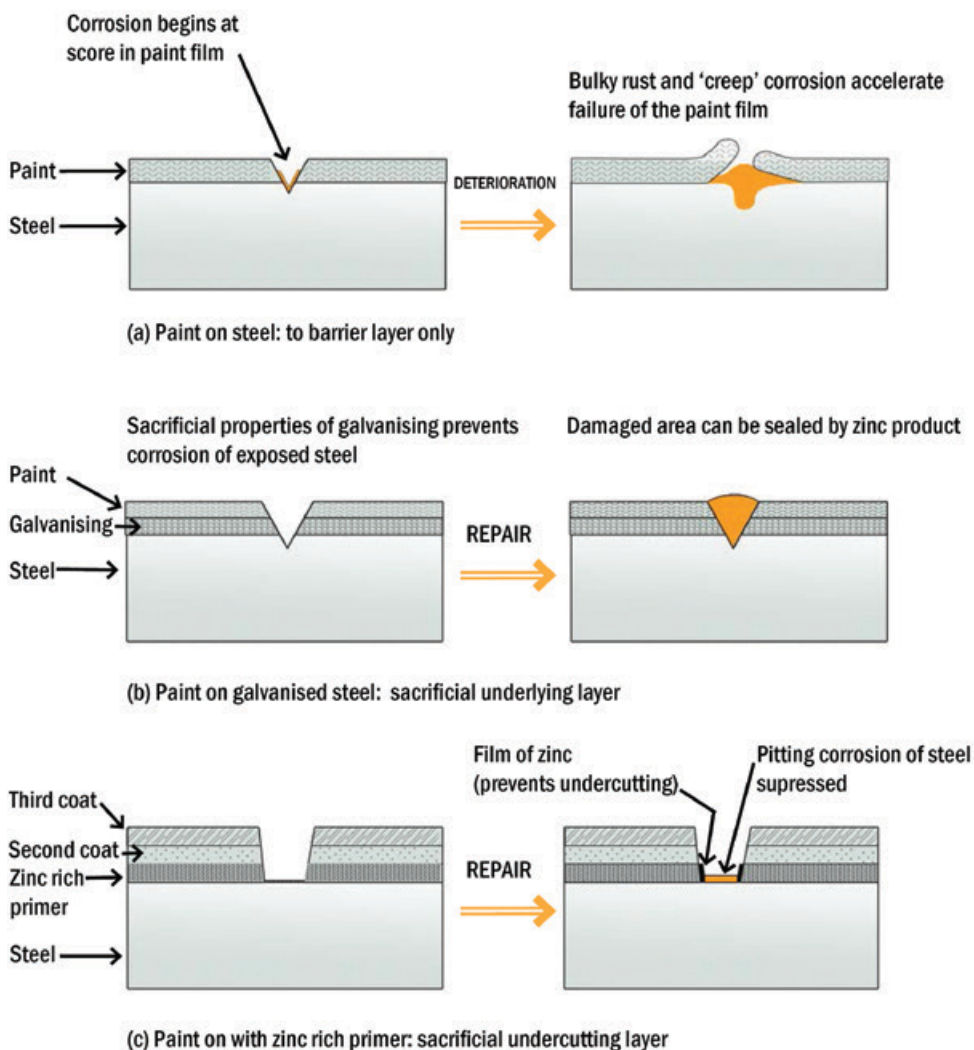

7.5 Inspection

Fundamental to an effective corrosion protection system is a regular inspection programme and well-kept records. Maintenance of paint coatings is most economically achieved by repainting before serious deterioration of the existing coating or rusting of the underlying steel.

Part of the maintenance inspection programme should be a:

- Regular cleaning schedule
- Programmed repainting plan where corrosion protection is provided by a predetermined coating system.

Inspections should be carried out at regular intervals determined by the environment but not less than:

- Six-monthly for a severe environment (Many dairy housing structures would constitute a severe environment)
- Yearly in a moderate environment away from coastal salt spray or in corrosive areas
- Every two years for mild sheltered inland areas.

7.6 Maintenance

The time to first maintenance is the expected time from application of a corrosion protection system up to when patch repair or recoating is first required as part of normal maintenance. Minor repairs to coatings during the construction maintenance period are not considered when determining the time to first maintenance (see Table 7.4).

Table 7.4: First Maintenance Criteria

Criteria for determining time to first maintenance:

- For scattered general breakdown of the coating system. For example, when a specified percentage of rust is visible. This could be under 0.5% of the total area for barrier coat systems.
- For more severe localised breakdown of the coating system. For example, welding damage, missed or undercoated areas, or when a specified percentage from 2% to 20% of the total area has occurred.
- Where blistering, flaking or rusting under the paint surface is evident.

Advice can be sought for the development of a maintenance programme from technical staff at major suppliers of protective coatings for industrial applications (see Table 7.5).

There are also specialist corrosion engineering and protective coating consultants who can provide independent advice. The Australasian Corrosion Association website would be a starting point to locate New Zealand contacts.

www.corrosion.com.au/Directories/Certified-Professionals/Coatings-Inspectors

On their website, they list the names of qualified Coatings Inspectors and Accredited Contractors. They can be approached for advice in corrosion control, weather, chemical and abrasion resistant coating systems for steel, alloys, and concrete surfaces.

Table 7.5: Coating Systems Maintenance Programme Considerations

In consultation with specialist advisors, consider:

- Design service life for the component
- Site-specific corrosivity category. This is derived from the first year steel corrosion rate and is a combination of macro/micro climate.
- Time to first major maintenance required for the coating systems
- An appropriate corrosion protection system to meet (2) and (3) based on cost, performance against any owner-specified factors such as colour and appearance

7.7 Accessibility

If the components of a structure are not accessible for maintenance after assembly, the corrosion protection system must remain effective for the specified intended life of the structure. If this cannot be achieved, other measures should be taken, such as, manufacturing from a corrosion resistant material, designing for replacement or specifying a corrosion allowance.

Also, note that the design service life is not the same as the “durability rating”, which is the number of years to first maintenance.

7.7.1 Maintenance access

Consideration should also be given to how roof areas will be accessed to safely carry out maintenance tasks such as:

- Repairing and cleaning out gutters and downpipes
- Roof wash down
- Roof repairs
- Painting
- Replacing building components.

Key points

Steel performance will be enhanced where the design of the building:

- Includes compatible metals
- Allows steel components to be regularly rain washed (if they are not kept dry and free from contamination)
- Does not create surfaces where moisture and airborne contaminants can accumulate
- Provides ready access for maintenance
- Complies with New Zealand specifications and standards
- Is delivered with a building maintenance plan.

8. Plastic Roof Covering Options

8.1 Rigid Polyvinyl chloride (PVC) and Polycarbonate (PC) sheeting

Rigid clear polycarbonate (PC) sheet is mainly used in buildings as an alternative to glass or acrylic. Sheets may be twin-walled, are lightweight, resistant to impacts, and have good initial transparency. However, sheets need to be fixed to the manufacturers recommendations, for example with a specific type of “Tek” screw. Some twin-walled types have flutes and provide a level of insulation that single sheets do not offer. However, internal cavities are prone to condensation forming, leading to dust adhering and algae growing inside these areas if they are not sealed off.

Rigid polyvinyl chloride (PVC) cladding products are also lightweight and generally do not require painting or lengthy maintenance. They are resistant to moisture, rotting and insects.

PC and PVC materials are often used alongside other roofing or cladding materials such as corrugated roofing iron to provide natural light into a building.

When used as part of the building envelope, both materials are typically required by the New Zealand Building Code to have a durability of 15 years. As these materials degrade under New Zealand’s high ultraviolet (UV) levels, the formulation of the material and choice of correct UV stabilising coatings or additives is crucial to achieve an acceptable service life.

BRANZ reports, “When tested 11 years after installation, the PVC claddings retained their tensile strength, and after 18 years, the remaining samples are still satisfactory. The impact strength has declined after 18 years and is quite low. However, all claddings remain undamaged by hail or other hard body impacts.”

In comparison BRANZ report, “The PC sheeting has now become brittle, but has not been broken by hail or other impacts. Some delamination of the protective coatings can be seen on some samples, and most samples are now very hazy. This haze is caused by surface micro-cracking, which also reduces the impact strength of the sheet.”

8.1.1 BRANZ guidance for specifiers

The performance of the rigid PVC cladding is dependent on the PVC formulation. Some claddings will perform much better than others based on formulation alone. The major suppliers are generally able to offer guidance on optimising formulations.

The main lessons for specifiers are that:

- White PVC claddings outperform darker colours from the same manufacturer
- The greater the roof pitch, the better the PC sheets retain their properties
- PC sheet durability depends on the quality of the protective coating on the surface of the sheets facing the sun. (Note: when installing, the manufacturers intended upper side needs to be identified.)
- PC sheets with protective layers of acrylic coating appear to weather better than surfaces that only incorporate UV light absorbers
- Barrel vaulting does not appear to significantly affect PC sheet durability, but the part of the sheet closest to the horizontal weathers the fastest
- Lighter coloured PC sheets consistently outperformed their darker coloured equivalents.

8.2 Flexible plastic roof covering options

8.2.1 Polyethylene film

Polyethylene (PE) film is the lightest option for roof covering of agricultural buildings. Manufacturers of PE film make different grades, based on the number of years it is expected to last if properly installed and kept clean. Ultraviolet (UV) light quickly degrades PE film so it needs to be selected with high UV protection embedded in the plastic especially in New Zealand conditions. “Natural” polythene is highly UV sensitive and breaks down in weeks. The polythene used in agricultural buildings is a composite material.

Some PE films also have chemical properties manufactured into them to reduce the amount of condensation on their surface. Others are able to reflect radiated heat back into the building, much like glass does. While this can make these types of plastic films more energy-efficient at certain times of the year, they can also overheat the building at other times.

White PE can reflect some of the sun’s heat and reduce the internal temperature rise that occurs inside the structure on hot days.

8.2.2 Polyvinyl Chloride (PVC) film

Polyvinyl chloride (PVC) film has many of the same qualities of PE film. While PVC film is more expensive than PE film, it typically lasts up to five years longer. PVC plastic is available with UV protection and condensation reducing additives.

Materials used in the manufacture of PVC film tend to act as a magnet to dust particles in the air. Periodic surface washing will be required, especially in locations where rain showers are infrequent. Even where rainfall is high, it is not sufficient to dislodge the dust without the use of a wash broom. Some chemical washes, including some citrus-based cleaners, have proven to be suitable aids to cleaning.



Plastic (clear PVC) roof



Plastic (opaque) roof

8.2.3 Double walled plastic

It is possible to install either PE or PVC plastic film in a double layer over a roof frame to make the exterior more durable. The outer sheet provides some bounce to spill wind load. However, in high winds with insufficient inflation pressure the flap can fatigue the point of fixing due to the repeated flex.

Structural design may need to reflect that loads are not evenly distributed across truss members and fall mainly on the edge supports of a given panel of film.

For a double wall of plastic film, a fan blowing air between the two layers will assist in keeping them from adhering to each other. The air gaps should not be too big as anything over approximately 100 millimetres separation has little thermal insulation effect and provides greater opportunity for flapping. Power cuts can be a problem, but a back flow preventer flap on the blower can help keep the roof inflated for some hours. As power failure is often associated with storms that bring down power lines, the risk of wind flap damaging the film during this time is high.

Light transmission into a building through a single layer of PE or PVC can be 85 to 90 per cent of full sunlight. The addition of a second layer of the same plastic film can reduce transmission further; for example $90\% \times 90\% = 81\%$. Cows favour shade on sunny days and so double layering can be a distinct advantage.

8.3 Shade options

8.3.1 Roof shade

For plastic roof covered buildings, adjustable or fixed shade curtain cloth can be designed to fit under the roof structure to increase shade.

Covering materials for shade and heat retention include knitted polyester, non-woven bonded polyester fibre and composite fabrics. These are available in various weights often quoted in grams per square metre (g/m^2). Types of composite fabrics include flame-resistant fabrics to meet building code requirement, woven fabrics with gaps for air circulation, and fabrics with chemical stabilisation or proprietary coatings to reduce the rate of breakdown by UV light. Some heavily UV stabilised PE fabrics can last for up to 15 years depending on its operating environment.

An interior curtain system can be operated for not only shade, but also heat retention and day-length control. Small systems are often moved manually while large systems can use a motor drive.

These types of systems are used extensively in the horticulture industry. However, as the optimal requirements for producing housed cows and plants are quite different, care is required in the operation of shade curtains. Best use of these systems for cow housing will depend on the geographical location, time of year and how the building is used to support the dairy operation.

8.3.2 Side shade

Side roll plastic film and shade cloth is frequently used for exterior walls. The issues of fixing, movement and wind flap need to be considered in its design, specifically:

- Fixing of edges and allowances for seams to prevent woven fabric fraying are critical issues
- Frequent movement can fatigue and abrade the fabric especially where it rubs or snags on supports
- Rolled plastic films can build up heat in the air gaps leading to rapid deterioration of the film
- Water trapped in the folds can grow algae.

8.4 Other plastic film considerations

8.4.1 Insurance cover

Designers and farm owners should be aware that some insurance companies will not insure farm buildings that are enclosed with flexible plastic covering, especially in areas of New Zealand subject to high wind exposure.

8.4.2 Gutters

Gutters need to be designed to have sufficient strength to hold the weight of water in high rainfall events. Further, if the gutter is blocked or overflows, the consequential effects on any adjacent plastic film has to be allowed for in the design. The building gutter design also needs to allow for access for installation, cleaning, and replacement.

8.4.3 Edge fixing

Where plastic contacts a steel truss surface that faces towards the sun, plastic sheets can burn through or have accelerated degradation. A suitable white reflective strip is often fixed to the contact surface or the truss powder coated white. Some plastic tapes react with the plasticisers in the films and soften them. Wind induced rubbing can abrade and damage the plastics at the contact point.

One of the most critical issues is the edge fixing system which must hold the sheet(s) firmly but also allow regular removal and replacement when the plastic is past its useful life. The best are two-piece aluminium base and cap systems.

8.4.4 Repair

Repair tapes are available formulated specifically for the type of film, so that the adhesives last but don't dissolve the film. Ease of repair should be considered when deciding which film to purchase.

9. Concrete

9.1 Concrete - key design and construction principles

A well specified concrete is essential to a well performing concrete slab floor for buildings which houses cows. For covered structures, the BC and NZS 3604 Timber Framed Buildings require concrete slabs to perform as designed for at least 50 years without needing reconstruction or major renovation.

To achieve this performance the design and construction should be based on:

- A reinforced slab thickness designed to meet expected durability and loading conditions
- Concrete with a moderately high cement content and tight pore structure to resist acid attack
- A well finished concrete to close up and densify the top surface whilst ensuring that required skid resistance is met
- Protection of the slab surface from drying throughout the finishing process, that is before curing, to prevent plastic shrinkage cracking
- Attention to curing of the concrete immediately after finishing to optimise cement hydration in the top surface layer
- Placement of shrinkage control joints in the slab to avoid cracking as the concrete dries out.

9.2 Guidance documents - concrete

Table 9.1: Relevant New Zealand concrete standards

| Standard | Detail |
|---------------------|------------------------------|
| NZS 3101 and 2:2006 | Concrete Structures Standard |
| NZS 3109:1997 | Concrete Construction |

IPENZ Practice Note 27: Dairy Farm Infrastructure, Part 4: Concrete Structures offers general guidance around concrete design and construction, while Part 5: Feed Pads, contains further information specific to reinforced concrete floor slabs. Table 9.2 provides a summary of relevant chapters.

Table 9.2: IPENZ Practice Note 27 cross-references

| IPENZ Practice Note 27: Dairy Farm Infrastructure | |
|--|------------------------------|
| Part 4: Concrete Structures | |
| Chapter | Subject |
| 4.1.1 | Specified Intended Life |
| 4.1.2 | Factors Affecting Durability |
| 4.2.1 | Cracking |
| 4.3 | Compressive Strength |
| 4.4 | Specifying Concrete |
| 4.5 | Placing, Finishing, Curing |
| 5.1 | Reinforced Concrete |
| 7.3 | Storage Structures |
| 7.4 | Foundations |
| 7.5 | Floor Slabs |
| 7.6 | Nib Walls |
| 7.7 | Surfacing |
| Part 5: Feed Pads | |
| 5.1 | Slab Design Considerations |
| 5.2 | Design Life |
| 5.3 | Exposure and Load Conditions |
| 5.4 | Concrete Design - Durability |
| 5.5 | Concrete Design - Loading |

9.3 Loading

Table 9.3 provides recommendations applicable to dairy housing floor slabs for given load conditions and should be read in conjunction with other design guidance.

Table 9.3: Nominal Slab Thicknesses, Concrete Strength, and Reinforcement for Typical Farm Loading Conditions.
Adapted from *Cement and Concrete Association of New Zealand (CCANZ) Information Bulletin 55: Concrete for the Farm.*

| Slab Loading (vehicle weight) | Temporary Structure | | | Design Life 50 Years | | |
|-------------------------------|---|---------------------------------|--|-----------------------------|---------------------------------|--|
| | Minimum slab thickness (mm) | Minimum concrete strength (MPa) | Reinforcement | Minimum slab thickness (mm) | Minimum concrete strength (MPa) | Reinforcement |
| Cattle & quad bikes only | 100 | 25 | 2.27 kg/m ² or Mesh Type SE62 (minimum of 30 mm from the top surface) | 150 | 30 | 3.40 kg/m ² or Mesh Type SE82 (minimum of 30 mm from the top surface) |
| Less than 3 tonnes | 125 | 25 | | 150 | 30 | |
| 3-10 tonne | 125-150 | 25 | | 150 | 30 | |
| Over 10 tonne | Design should be undertaken, or directly supervised by a Chartered Professional Engineer with experience in the design of ground floor pavements, and based on the loaded vehicle configurations and weights intended to be used. | | | | | |

9.3.1 Concrete reinforcement

The load a slab can carry is dependent on the adequacy of the sub-grade to support the loaded slab. Reinforcement provides robustness to the slab by holding the slab together in the event of an accidental overload. The reinforcing steel does not increase the load capacity of the slab, it is only required for shrinkage control.

Synthetic fibres, such as polypropylene, nylon, and polyester are often added to a concrete mix as a mitigation measure to prevent plastic cracks forming.

Note:

- Synthetic fibres should not be used to replace structural steel reinforcement
- Synthetic fibres are weak in tension and are no substitute for reinforcing mesh to prevent concrete shrinkage cracking; they add little or no strength
- Synthetic fibres should not be used in concrete which cows will be feeding or standing on because, as the surface wears, the fibres become exposed and cause injury to the tongues and feet of cows.

9.4 Concrete properties

Concrete is a highly alkaline material that can quickly deteriorate when exposed to the acidic conditions typical of dairy farm facilities. Sour milk, dairy effluent, and silage leachate can lead to damaging acid attack and the continuing deterioration of concrete floor surfacing. A pH of 5.5 is regarded as the most acidic level a well-specified concrete can resist. Concrete, and more particularly the lime in the cement, will not withstand prolonged or repeated exposure to substances with pH lower than 5.5. Poured concrete has a high pH value often up to 12 while the pH of silage can be as low as 4.

9.4.1 Durability

The more durable concrete is, the better it is able to resist acid attack. Specific additives also known as supplementary cementitious materials (SCM's) are available that can improve impact resistance, permeability as well as durability and acid resistance to an otherwise lower strength concrete. However, these additives can be expensive, and in some cases spending extra on a higher strength concrete is a better long-term investment.

Durability is further influenced by the depth of concrete cover over the reinforcement and the sealing of cracks and joints. Floors subject to frost need to be constructed from concrete specifically designed to be resistant to freeze-thaw attack.

9.4.2 Abrasion resistance

Abrasion resistance is also critical in the performance of concrete floors subject to wear and tear from moving machinery and scraping activity. In general, the stronger and less permeable the concrete surface is, the more durable it will be. A concrete central passageway is particularly prone to degradation as it is subject to a combination of heavy vehicle loadings, abrasive scraping and acidic feeds.

Consideration should be given to placing concrete of different strengths into different floor sections to reflect the expected abrasion and acid attack during the life of the building. Internationally it is common to line the edge of the central passageway where feed is placed with an acid resistant brick or tile.

Table 9.4 provides good practice guidance for the minimum specified compressive strength of concrete floors based on a medium to long-term design life for high and moderate abrasion service conditions.

Table 9.4: Compressive Strength Guide for Concrete Floor Slabs Requiring Abrasion and Acid Resistance

| Required Performance | Application | Finishing Process | Curing | Minimum specified compressive strength (f'_c) |
|---------------------------------------|---|---|--|---|
| High abrasion and acid resistance | Areas subject to feed out, scraping and heavy vehicle movements. For example, central passageways, scraper beds and feed pads | Power floating and at least two passes with a power trowel before applying a slip resistant surface texture | Seven days water curing using ponding or covering; or the use of curing membrane that meets NZS 3109 | 35 or 40 MPa (depending on risk profile) |
| Moderate abrasion and acid resistance | Areas subject to cow standing, wet feed placement, dairy effluent and light vehicle movements. For example, feeding passageway or alleys, stalls, feed bunkers, effluent pits and channels | | | 30 MPa |

Note: Where the slab design for the intended application needs to meet both this table and loading requirements (from Table 7.14), the minimum concrete strength selected should be the higher of these two values.

9.4.3 Value For money decisions

If the building is being designed by a Chartered Professional Engineer according to building code requirements, a design life of 15 years is not uncommon for certain specified building elements, including concrete floors, where such replacement is recognised at the outset. However, the concrete floors in dairy facilities perform much more than a building structural function.

Concrete can be exposed continuously to the aggressive chemicals throughout the life of the structure. Although it may be possible to reinstate the concrete surface once the damage becomes significant, such repair is expensive and the facility cannot be used while this is being carried out.

While it may be argued that most of the at-risk building elements are likely to be obsolete and will require significant modification within the 50-year service life specified by the New Zealand Building Code, nevertheless building for a shorter period reduces tolerances and may consequentially limit the options for re-use of the structure when it is eventually upgraded.

The adoption of a lower strength concrete at the time of construction might reduce initial capital costs, but it will likely lead to higher ongoing maintenance costs and earlier replacement of the concrete floor. Further, a deteriorating cracked and damaged surface may lead to greater environmental and animal health risks. The cost of higher grade and strength concrete is therefore usually justified. It is recommended that a “whole of building life” cost approach be adopted in the concrete slab thickness and strength decision.

Appendix, *Specifying Concrete Floors for Dairy Farms* contains some useful guidelines in preparing a specification that could be given to a rural contractor. The Concrete and Cement Association New Zealand (CCANZ) provided this text specifically for this Practice Note.

References

DairyNZ

IPENZ Practice Note 27 Dairy Farm Infrastructure, Version 1, September 2013

www.dairynz.co.nz/publications/environment/ipenz-practice-note-27-dairy-farm-infrastructure/

New Zealand Timber Industry Federation Inc

Timber Industry Guide

www.bifnz.co.nz/index.cfm

BRANZ

BUILD

www.buildmagazine.org.nz/

Timber Treatment (1 February 2012, Build 128)

www.buildmagazine.org.nz/articles/show/timber-treatment/

Corrosion of Fasteners (1 August 2009, Build 113)

www.buildmagazine.org.nz/articles/show/corrosion-of-fasteners/

Storm Damaged Roofs (1 April 2011, Build 123)

www.buildmagazine.org.nz/articles/show/storm-damaged-roofs/

Choosing a Nail or Screw for 50-year Durability (1 June, Build 118)

www.buildmagazine.org.nz/articles/show/choosing-a-nail-or-screw-for-50-year-durability/

Understanding Fasteners (1 April 2010, Build 117)

www.buildmagazine.org.nz/articles/show/understanding-fasteners/

Stainless Steel Considerations (1 August 2013, Build 137)

www.buildmagazine.org.nz/articles/show/stainless-steel-considerations/

PVC and Polycarbonate Sheets (1 August 2008, Build 107)

www.buildmagazine.org.nz/articles/show/time-tests-pvc-and-polycarbonate-sheets/

Resilient Building Design (1 April 2014, Build 141)

www.buildmagazine.org.nz/articles/show/resilient-building-design/

Durability and Exposed Steel Beams (1 October 2011, Build 126)

www.buildmagazine.org.nz/articles/show/durability-and-exposed-steel-beams/

Galvanic Corrosion (1 August 2009, Build 113)

www.buildmagazine.org.nz/articles/show/stainless-steel-considerations/

Cement and Concrete Association of New Zealand (CCANZ)

Information Bulletin 55: Concrete for the Farm

www.ccanz.org.nz/files/documents/8c8eadef-290f-4c65-8de2-0852d5dcb894/IB_55_Concrete_for_the_Farm_2012.pdf

New Zealand Heavy Engineering Research Association (HERA)

New Zealand Steelwork Corrosion and Coatings Guide, HERA Report R4-133:2011, published February 2011

www.hera.org.nz/Category?Action=View&Category_id=647

Concrete Construction

Synthetic Fibres

www.concreteconstruction.net/Images/Synthetic%20Fibers_tcm45-342406.pdf

Appendix

Specifying Concrete Floors for Dairy Farms

1. Concrete specification

The following text and comments, which can be expanded on, is offered to provide the basis of a suitable specification:

The specified strength shall be xx MPa with a 20 mm maximum aggregate size. The concrete shall be supplied from a Ready Mixed Concrete Plant holding a current certificate of audit in accordance with NZS 3104 Specification for concrete production.

Comment: The slump of the concrete should be discussed with the concrete supplier and will depend on the method of placement of the concrete (by pump or direct from the truck), and the use of admixtures dosed on site if the concrete plant is some distance away.

Supplementary Cementitious Materials (SCM) such as amorphous silica fly ash, or ground granulated blast furnace slag if used as a partial replacement for cement will produce more concretes that are acid resistant. Such concretes will generally be more expensive and may not be available from all plants. Microsilica 600, a proprietary amorphous silica, is supplied as a bagged product and thus may be more readily available to ready mix concrete suppliers in rural areas. Admixture suppliers may also supply silica fume in convenient form.

1.1. Concrete placing and finishing of surfaces

Key placing and finishing steps:

- (i) Screed the concrete to correct levels
- (ii) Compact the concrete using a mechanical vibrating screed or poker vibrator to give dense concrete
- (iii) Bull float to close off the surface
- (iv) Leave the surface to bleed
- (v) In hot windy conditions use misting or an anti-evaporative spray to prevent plastic cracking as per manufacturer instructions
- (vi) Power float the surface after the bleed water has evaporated and the concrete has stiffened
- (vii) Provide the type of non-slip finish specified.

Comment: The power floating of concrete slabs carrying stock is important to create a surface dense enough to resist acid attack and hard enough to provide resistance to wear from stock.

Skid and slip resistance can be provided from a coarse broom finish (NZS 3114 U2 finish).

1.2. Curing and hardening of pavement surfaces

One of these methods of curing shall be used:

- (i) Water cure - keep the exposed surface continually wet by sprinkling, mist spray or ponding
- (ii) Polythene cure - Cover the entire surface with polythene sheet, held down at the edges to prevent moisture loss
- (iii) Proprietary membrane cure - Apply a film forming membrane to the surface which meets the requirements of NZS 3109 clause 7.8.2, to the surface

Comment: Premature drying of the concrete surface after placing will compromise cement hydration. As a result, the surface will be weak and lack the hardness required for abrasion resistance. One of these curing methods must be used to prevent the surface concrete drying out at an early age.

Concrete floors should not be loaded before 7 days old in summer or 14 days in winter. Stock should be kept off the floor for 28 days.

1.3. Shrinkage control

For shrinkage control Grade 500E steel mesh reinforcement (generally) shall be placed in all concrete slabs. The mesh shall be placed on mesh chairs at recommended centres to position it a minimum 30 mm cover from the top of the floor. Saw-cutting shall take place within 24 hours of finishing for ambient temperatures above 20°C, and within 48 hours for ambient temperatures below 20°C. Distance between saw cuts shall not exceed 5 m and bays shall generally be square with the aspect ratio of bays not exceeding 1.5:1.

Comment: Concrete shrinks as it dries out and because it has a low tensile strength the floor will crack. The placement of joints at even centres, along with mesh, dictates where shrinkage cracks will occur. Joints are formed either by saw cutting, casting in proprietary crack inducers or tooling the concrete before it hardens.

Without the adoption of special precautions, higher strength concrete and concretes containing SCM are susceptible to cracking within hours of placement under weather conditions that promote rapid drying of the concrete surface.

The presence of steel mesh will ensure that the shrinkage cracks open up evenly and not too wide. Appropriate curing will also reduce the risk of uncontrolled shrinkage cracking.

(The involvement of Concrete and Cement Association NZ (CCANZ) in the preparation of this guidance information is acknowledged.)

Chapter 8

Consents

1. Introduction

Every rural structure including buildings for housed dairy cows, must comply with the Resource Management Act 1991 (RMA) and the Building Act 2004 (BA). This legislation defines the situations in which a resource consent and/or building consent are required. Obtaining these consents will be less problematic if it is known how the proposed project might be affected by the requirements of the RMA and BA.

An overview of consenting to meet RMA requirements for farm infrastructure at the Regional and District Council levels is provided in IPENZ Practice Note 27: Farm Dairy Infrastructure Part 1, section 3. The BA is similarly discussed in relation to building consents in section 5 of the above Practice Note.

2. Resource Consents

2.1 Resource Management Act 1991

The RMA protects land and the environment. Just because rural land can be isolated from an urban population, does not mean the landowner can build any structure on it. The RMA recognises that neighbours and others in both urban and rural communities can be affected.

Under the RMA regional councils prepare regional plans that focus on the management of air, water, land and soil. City or district councils prepare district plans that focus on managing aspects of land use that can affect the environment such as the height, appearance and location of buildings, and the noise, glare and odour associated with the activities that take place in and around buildings. Every district or regional plan is different and reflects the desires and aspirations of the local community. The Proposed Auckland City Unitary Plan (PAUP) manage both the Regional and District aspects previously covered by the various Auckland Districts and Regional Plan.

2.2 What is a resource consent?

District and Regional plans set out which activities require a resource consent. A resource consent is a formal approval for activities such as the use or subdivision of land, the taking of water, the discharge of contaminants in water, soil or air, and the use or occupation of coastal space. It is not just new buildings that may require resource consent. The change of use of an existing farm building or farming activity may also trigger a consenting requirement.

Just as council plans vary, the need for resource consents varies from one area to another. Even if the particular activity is not clearly identified as either a permitted or prohibited activity in the plan, resource consent may still be required. If there is need for certainty, councils can issue certificates of compliance for permitted activities confirming that the activity can be lawfully established without the need for a resource consent.

2.3 District and Regional Plans

District and Regional Plans, generally through rules, state whether an activity is permitted or not. If the activity is permitted, it may be undertaken as of right, whereas if the activity is not permitted it will require resource consent from the local District and/or Regional Council. Every council in New Zealand is unique so it is important to assess the rules that relate to the district or region in question and not to rely on what has been allowed elsewhere.

Note for an activity to be permitted – it must not only be listed as such but must comply with all the standards in the plan for permitted activities. These standards could include distances from boundary, height of structure, volumes of earthworks or effluent etc. Again like the activity there is little consistency with regard to permitted development standards between different Councils.

2.3.1 Regional Plans

Regional councils in New Zealand, broadly speaking, manage natural resources including lakes, rivers, air, coastal and soil resources. These plans must be consistent with Government policies and directives such as the National Policy Statement for Freshwater Management.

For the development of dairy housing and other dairy infrastructure, resource consents will usually be required from regional councils for the storage and discharge of animal effluent.

Specific issues that may need to be addressed in a resource consent application include:

2.3.1.1 ODOUR

Regional councils may require resource consent for the discharge of odour from the structure. Canterbury Regional Council, for example, has regulations around the discharge of odour from dairy housing as well as odour from the collection, storage and discharge of effluent. Councils may require odour management to be regulated via the implementation of an odour management plan, or specific management measures such as pH limits on effluent.

DairyNZ Effluent Technical Note *Odour Management for Storage Ponds* provides guidance on how to manage odour. District councils may also have their own requirements around odour.

2.3.1.2 NITROGEN LOADINGS

Some regional councils regulate the nitrogen loadings or nitrogen and/or phosphorus loss associated with a farm's operation. This may result in the need to demonstrate compliance with nitrogen loading or loss limits or the need for a resource consent to farm. Determining the nitrogen loss limits may require the use of OVERSEER® or another approved nutrient budget calculator to determine a nutrient budget for the farm. Prior to a change in activity, be it a dairy conversion or increase of stocking rates, it is advised that farmers seek advice from Council regarding the nutrient limits for their farm and consider the impact any changes in operation would have to their existing budget prior to making any investment.

2.3.1.3 CONSULTATION

If the dairy housing or associated activities (that is, effluent collection, storage and discharge) may affect neighbouring properties, it is good practise to consult with these parties and advise them of your intentions. In many cases, written approval may be required from these parties (owners and occupiers) as part of your resource consent application. The Regional Council will be able to confirm this and recommend any further consultation with other parties such as iwi and Fish and Game New Zealand.

Table 2.1 lists a number of items of information that regional councils may require.

Table 2.1: Regional Council Requirements

| Meeting Regional Council Requirements? |
|--|
| <ul style="list-style-type: none"> • What regional plan rules are applicable to the development and/or operation of dairy housing? <ul style="list-style-type: none"> • Farming activity rules (that is, nutrient discharges) • Effluent collection, storage and discharge • Odour • Excavation • Earthworks – sediment and erosion control • Water use/take • Is the activity a permitted activity and what is needed to comply with the permitted activity? • Is resource consent/s required? • What information do I need to provide as part of the resource consent application? • Do I need any technical reports to support my resource consent application? <ul style="list-style-type: none"> • Massey University Effluent Storage Calculator • OVERSEER® budget • Engineering Design Statement • Odour Management Plan. • Who do I need to consult with and seek written approval from others? <ul style="list-style-type: none"> • Neighbours • Iwi • Fish and Game New Zealand. |

DairyNZ offers a very useful compliance check sheet for regional councils in New Zealand on their website.

www.dairynz.co.nz/page/pageid/2145874264/Compliance_With_Rules

2.3.2 District plans

Different areas within districts are typically classified as “zones”. Generally, rules differ from zone to zone. When checking the rules or standards for an activity, it is important to understand that there may be more than one set of rules or standards that can apply. Typically, districts will have specific zone rules (for example, Rural 1, or Rural A and B) that need to be adhered to. However, some districts may have district-wide rules (for example, earthwork rules).

To determine what rules might apply within a district plan it is important to first identify where the activity/proposal is located on the district’s planning maps. These planning maps will identify what zone the activity will be in and what zone rules apply. It is important to note that even though an activity is within the “Rural Zone”, some district plans may have a variety of different rural zones depending on the location and surrounding environment in that area. Some zones have special areas within them that also need to be considered. Table 2.2 highlights a number of questions that district councils may require satisfactory answers to, while Figure 2.1 provides an example of how to find a farm’s zoning and the relevant farm rules.

Table 2.2: District Council Requirements**Meeting District Council requirements**

- What zone is the farm located in and what are the requirements for this zone? (For example, rural, coastal or urban)
- Is resource consent(s) required for the development and/or operation of dairy housing?
- Do the District Plan planning maps indicate any special features that may be located on the farm? (For example, significant landscape area or flood zone)
- What information needs to provide as part of the resource consent application?
- Are technical reports to support resource consent application required? (For example, engineering design statement)
- Who, if anyone, needs to be consulted with and written approval obtained from for the resource consent application?

2.3.3 Certificate of Compliance

A Certificate of Compliance (CoC) from a District (or City, or Regional) Council is confirmation that an activity which is permitted by a District Plan does not need a resource consent. A CoC application must provide evidence outlining, what is proposed and the reasons a resource consent is not required. Councils may request further information where compliance has not been clearly established.

Applying for a CoC can be useful if interpretations of district plans are vague or undergoing continuing change. These can reduce project risks and consequential additional time and costs to meet unforeseen consent requirements.

Although a CoC is not a resource consent it has the same 'life' as a consent - generally allowing 5 years for the implementation of the activity outlined in the Certificate of Compliance. If you think that you might wish to undertake an activity that is permitted, but which might be subject to a change of District Plan Rule within the next 5 years, applying for a CoC to lock in development rights is advised.

Figure 2.1: How to Locate Relevant District Council Rules (Typically)

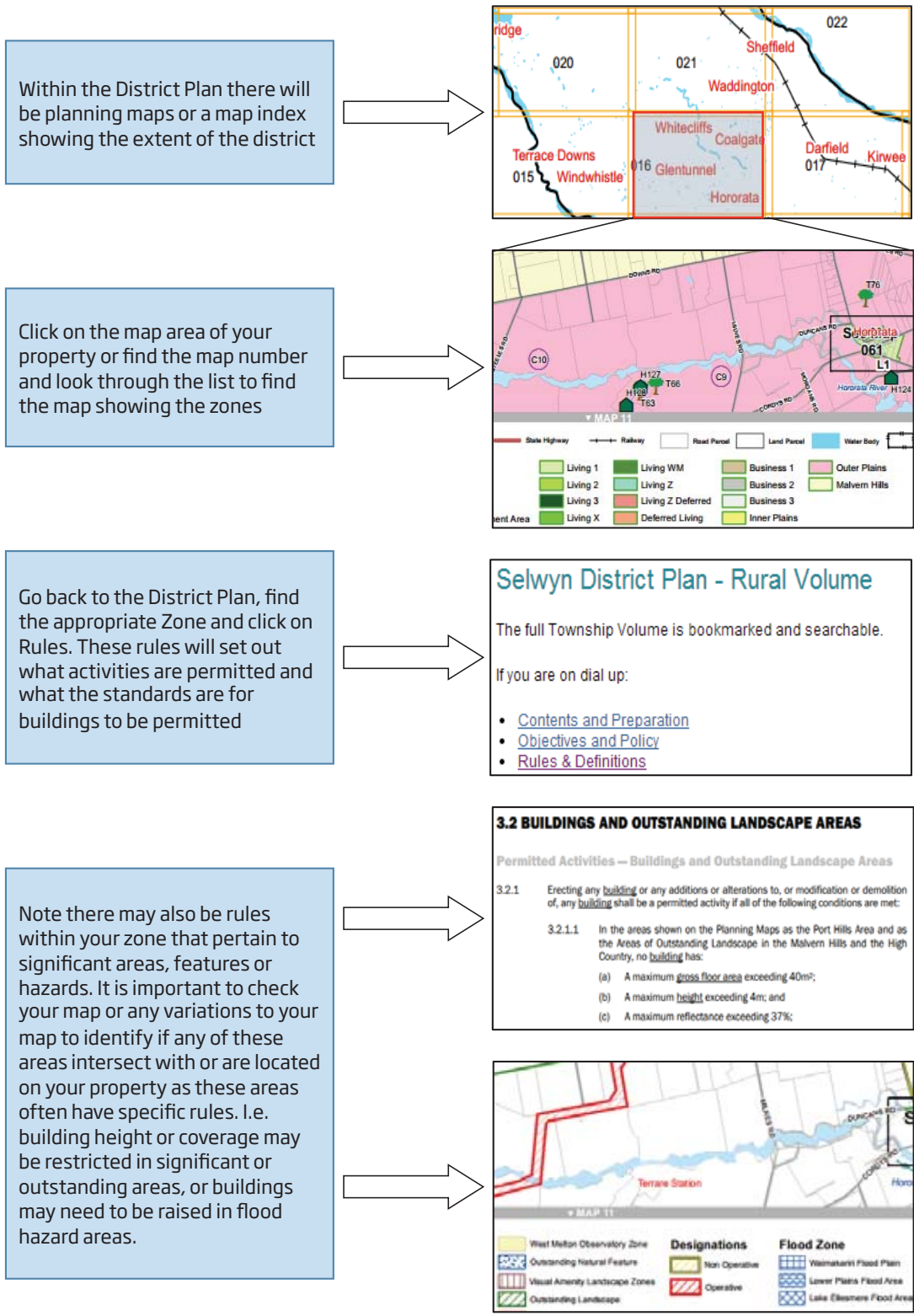

2.4 Classification of activity

Once the zone has been established, the next step is to determine what the activity is classified as. This will determine the resource consenting requirements. Activities are classified as outlined in Table 2.3. These are typically listed or tabled within district plans in the following respective order.

Table 2.3: Activity classifications

| |
|--|
| <p><i>Permitted</i> - activities are allowed 'as of right' subject to complying with any conditions set out in the plan. A permitted activity is the only category that does not require you to apply for resource consent.</p> <p><i>Controlled</i> - a council must grant consent if you apply for a controlled activity unless it has insufficient information to determine whether or not the activity is a controlled activity. The council may grant consent subject to conditions that must be complied with. These conditions may only be imposed when they relate to matters specified in the plan over which Council has exercised 'control' over.</p> <p><i>Restricted Discretionary</i> - a council may grant or decline consent for a restricted discretionary activity. If granted, conditions may only relate to matters specified in the plan that the Council has 'restricted their discretion' to.</p> <p><i>Discretionary</i> - council can grant or decline an application for a discretionary activity. If granted, it can impose conditions in relation to any matter that helps control any of the activity's potential adverse effects.</p> <p><i>Non-complying</i> - a council can only grant an application for a non-complying activity if its adverse effects are minor, or if it is consistent with the plans objectives and policies. The application must also have regard to both the effects on the environment and the provisions of the District Plan and any other matter Council considers relevant. If it grants consent, the council can impose conditions in relation to any matter that helps control the activity's potential adverse effects.</p> <p><i>Prohibited</i> - you cannot apply for a resource consent.</p> |
|--|

Some common terms used in district plans for housing of dairy cows may include; intensive farming, factory farming, livestock farming, animal housing or buildings housing animals. It is important that the definition for housing of dairy cows be checked within the district plan to ensure the activity is classified correctly. Some Councils also differentiate between the temporary housing of animals in wintering barns or under feed pads versus the permanent housing of animals.

For example, if the housing of dairy cows (livestock) is defined as intensive farming and under the district plan 'Rural Zone' and the 'Activity' it is listed as Permitted, a resource consent is not required and the activity can be carried out as of right. However, the physical structure used to house the livestock must still be assessed against the rules in the particular zone.

These structures are usually assessed against what is called the zone or development standards which set out the shape, height, setbacks and other conditions that need to be considered when constructing a building. These standards are set to ensure that development within the district is consistent with the purpose of the RMA - sustainable management of natural and physical resources.

District-wide standards such as earthworks or visual constraints are quite common. When assessing against these standards it is important that the proposed building be assessed against the relevant building standards. In particular, a building used for housing animals needs to be assessed against rules for that structure and not for dwellings or other buildings.

If the proposed building can meet all the standards for a permitted activity then a resource consent to erect the structure would not be required. Height, building coverage, setbacks from roads, residential boundaries and water bodies are usually specified within the district plan standards.

2.4.1 Rules for permitted activities in rural zones

To demonstrate the variety operating in New Zealand, the rules and standards for permitted activities in Rural Zones, for select councils only, are included in Table 2.4. These are subject to change and should not be relied on.

Note:

- Rules are subject to change and so the table contents should not be relied upon
- There are widespread rule differences between Councils around New Zealand.

Table 2.4: Rules for permitted activities in rural zones

| District | Rangitikei District Council | Whakatane District Council | Waikato District Council | Hauraki District Council |
|---|--|---|--|---|
| Earthworks limits | Rule B1.8: No limit unless inside an outstanding area where the limit is 1000m ³ | Rule 4.1.2.1: Not to exceed 200m ² and 100m ³ in the Rural 3 Zone. Other Zones 350m ² in area and 150m ³ in volume and meets a list or requirements. Also see Rule 4.1.5. | Rule 25.25: Extent of area permitted if complies with a number of conditions outlined under this rule | |
| Notes & Other Restrictions | Note: Rules also exist if within the Rural Living Zone | Intensive Farming defined as intensive livestock farming requiring buildings for housing animals. This activity is Discretionary | Special setbacks for the Waikato and Waipa Rivers and River Bank Stability Areas | Rule 5.1.5: Recession plane 2.0m in height at the boundary and not project above 45 degree angle |
| Maximum Height | Rule B1.5: Max height of building to be 10m | Rule 4.2.1: Rural 1 and 2 max height 12m on allotments greater than 5,000m ² . Rural 3 max height 7m, Rural 4 max height 8m. Recession equals Rule 4.2.1.2 | Rule 25.49 - Max height 10m unless within a specified area on planning maps | Rule 5.1.5: Max height 11m except in outstanding natural areas where the height is 8m |
| Site Coverage | | Rule 4.2.1.8: Rural 4 buildings not to exceed 40% of the land area. | Rule 25.51: Not to exceed 2% of the site area, or 500m ² , whichever is the larger also Rule 25.52: Gross floor area of non-residential not to exceed 400m ² , and if site is less than 2ha does not exceed 250m ² | |
| Boundary Distance (setbacks) Requirements | Rule B7.1: 20m setback from rear and side boundaries, 10m to an existing State Highway and 5m to other roads. Rule B7.7: 15m from a river, lake or wetland and 350m to Mean High Water Spring | Rule 4.2.1.3: Front yard 15m, side and rear 5m for rural 1-3. Rural 4, 4m front and 3m other boundaries. All buildings to be 20m from bed of river or lake | Rule 25.53: 12m from the road boundary, 22m from the centre line of an indicative road, 25m from an expressway or proposed expressway, 15m from a State Highway. Rule 25.54: 25m from all other boundaries than roads. Rule 25.59: 32m from lake of 8ha or greater, bank of any river, wetland of 1ha or greater | Rule 5.1.5: 50m of any boundary |

| District | Gore District Council | Ashburton District Council | Selwyn District Council |
|---|--|--|--|
| Earthworks limits | Rule 4.13.1: Any land use activity that involves earthworks or results in the disturbance of the ground where the period from the commencement of such earthworks or disturbance until the completion of rehabilitation work exceeds 12 months is a restricted discretionary activity | Rule 3.9.13: Rural C Zone shall not exceed 2000m ³ (volume) or 2000m ² (area) in any one hectare in any continuous 5 year period. In Rural A and B shall not exceed a maximum of 5000m ³ (volume) over an area no greater than 2000m ² on any one site per annum. No earthworks within 20m of a naturally occurring wetland; or 100m of any lake; or 20m of any river or stream | Rule 1.7: Greater than 20m from water body, except that for rivers the following are subject to a reduced setback of 5m: 100m ² per 1000m in any continuous 5 years, 40m ³ (volume) per 1000m in any continuous 5 year period |
| Notes & Other Restrictions | Rule: 4.7.1: No building or other structure shall extend beyond the recession plane calculated from diagram 4.2 | Partly Operative District Plan. Additional rules apply to flood risk areas. | Restrictions on outstanding landscapes and natural hazard areas and high country. Reflection restrictions on materials. Intensive farming definition |
| Maximum Height | Rule 4.8.1: No structure shall exceed 12m in the rural zone | Rule 3.9.3: Max height 20m in Rural A and B, Rural C all buildings 15m | Rule 3.12: Max height 12m |
| Site Coverage | Rule 4.9.1: Structures on 2ha or less do not cover more than 40% of the site area or 500m ² (whichever is the lesser) (ii) Properties over 2ha structures used for sheltering animals shall not exceed 1,500m ² | Rule 3.9.2: Maximum area 10% of net site area or 2000m ² whichever is the lesser (Rural A), 5% of net site area (Rural B and C) | Rule 3.11: Max area covered by building 35% of 500m ² whichever is less for lots under 1ha, 5% for all other lots. Rule exempt for farming operations established before 8 September 2001 |
| Boundary Distance (setbacks) Requirements | Rule 4.7A1: Any building housing animals shall be located no closer than (i) 30m from a legal road boundary; and (ii) 50m from any other property boundary. All buildings shall be set back 6m from any waterway more than 2m in width | Rule 3.9.4: 50m from road boundaries Rule 3.9.5: 80m from internal boundaries of any site in separate ownership. Rule 3.9.8: All buildings to be minimum of 100m from the centre line of any stop bank erected by the ECan. Rule 3.10.3: Buildings over 100m ² in area must be 400m from an existing residential unit on a site held in a separate title | Rule 13.13: 30m from property boundaries and roads. 100m from a lake/wetland; 20m from any water body in appendix 17 other than lake, 10m from any other water body |

2.5 Preparing the resource consent application

If a resource consent is required for part, or all, of the proposed building work, application forms can be obtained from the relevant council, or online from that council's website. As part of this application, an assessment of environmental effects (AEE) must be completed. Any persons or party that may be affected by the proposed activity must be identified along with how they might be adversely affected. Formal consultation may be required. Consultation can highlight issues not sufficiently thought through during the development of the project that may lead to time delays while they are resolved.

If it is determined that a resource consent is required, the consent must be obtained before any of the proposed work is undertaken. If work begins before consent is granted there is a risk of prosecution.

This risk can be reduced through early engagement with councils, even before the Project Information Memorandum (PIM) request stage. Some councils are not experienced with dairy housing facilities so gaining an understanding of their interpretation of how their regional and district plans apply to the project, and discussing alternative views, can be helpful before formal application is made.

Some councils require effluent consents to be in place before they will process a building consent for dairy housing. Check with individual district (or city) councils as to what their processes require.

Figure 2.2 demonstrates a typical district council consent application process.

Figure 2.2: Typical District Council Resource Consent Application Process

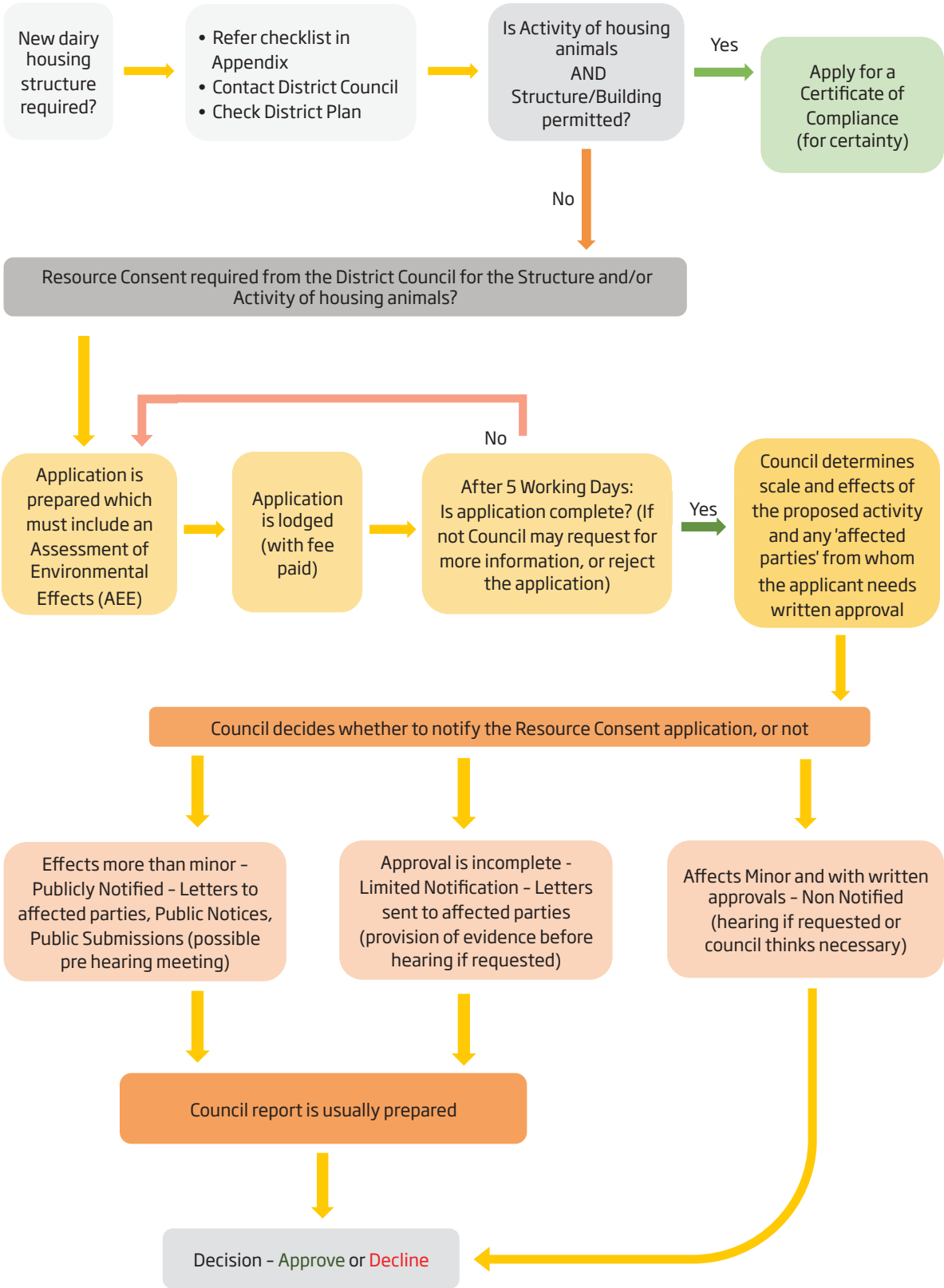

2.6 Preparing an assessment of environmental effects

A critical part of the resource consent application is the preparation of the assessment of environmental effects (AEE).

Every activity has some effect on the environment whether positive or negative. For example, a new building might cause a loss of amenity values on the landscape or its footprint may affect soils that may have otherwise been highly productive.

Section 88 and the Fourth Schedule of the RMA 1991 sets out that all AEEs should include the following information in Table 2.5 (unless the council's plan states otherwise).

The AEE needs to describe all the environmental effects of the proposed activity and the ways that any negative effects are to be mitigated (reduced). The "Activity Classification" will give an indication of what needs to go in an AEE. Table 2.6 provides an example of identifying environmental effects.

For controlled or restricted discretionary applications, the District Council plans generally state what matters the Council has control over or restricts its discretion on and states the effects it is concerned about. The AEE needs only address these effects. For discretionary or non-complying activities, the AEE may need to be more substantial. This is because the specific environmental effects determine the degree of impact and hence the comprehensiveness of the AEE.

Providing too much information that may be irrelevant can become time consuming and costly. On the other hand, an inadequate AEE may result in the need for changes to the proposal, increased processing costs, significant time delays, increased chance of the proposal becoming notified or requiring written approval, and reduced chance of the application being approved.

Table 2.5: Assessment of Environmental Effects (AEE)

What should an Assessment of Environmental Effects (AEE) include?

- A description of the proposal, including the location and site
- A site plan that is drawn to scale and other plans such as elevations of new buildings
- A description of all of the potential environmental effects of the activity (positive and negative)
- Where the above effects are likely to be significant, a description of available alternatives
- A discussion of the risk to the environment from hazardous substances and installations
- For contaminants, an assessment of the nature of the discharge and sensitivity of the receiving environment to the adverse effects and any possible alternative methods of discharge, including discharge into any other receiving environment
- A description of how the adverse environmental effects can be avoided, remedied or mitigated
- Identification of any people and properties that may be affected by the proposal
- Details of any consultation undertaken (including affected parties if any)
- A discussion of any monitoring of environmental effects that might be required
- Where an effect needs to be controlled, a discussion of how it can be controlled and whether it needs to be monitored. Where appropriate, a description of how this will be achieved and by whom.

Table 2.6: Example of identifying environmental effects process

(Adapted from MfE - Guide to preparing a basic Assessment of Environmental Effects 1999 (Updated 2006))

| Activity: Construction of a Large Dairy Housing Structure | | | |
|--|--------------------------|--|---|
| Example of Environmental effects | Ranking of effect | Avoid/remedy/mitigate effect | AEE action |
| Identify possible temporary effects: noise/dust/vibrations/emissions/hazardous substances/odour/land contamination from construction | | | |
| Noise from construction | Minor | Noise from construction will be minor due to the distance from the construction site to the neighbouring property | May need specialist advice on noise levels. Mention in AEE |
| Identify possible permanent effects: visual effects. Loss of trees and vegetation, shading neighbouring property, soil stability, privacy, stormwater capacity, traffic generation, landscape changes, effects on water quality/quantity, cultural/spiritual values on iwi, effects on heritage sites/buildings/structures/objects, pollution, loss of recreational values and so on. | | | |
| Visual effects | Significant | Negative visual effects of the new house on the natural landscape will be mitigated by extensive native planting, softening the appearance | Need to show landscaping plan in AEE and discuss how visual impacts of the new building will be mitigated |
| Shading neighbour's property | No effect | The new building and trees will not shade the neighbour's property because of the distance between the two | Mention in AEE |
| Identify possible cumulative effects: change in character, loss of vegetation, effects on waterways, landscape, effects on infrastructure etc. | | | |
| Disturbance to vegetation | Minor | Vegetation will be replanted following construction, therefore having no long-term cumulative effects on vegetation | Describe landscape design and ability to restore and add to vegetation in AEE |
| Positive Effects (potentially) | | | |
| Better effluent management, reduced feed requirements, better pasture growth/regeneration, less erosion, improved animal welfare, increased productivity | | | |

2.7 Consultation requirements

Consultation involves talking with any person who may be affected by the proposal. It is an opportunity to communicate what is planned and for others to contribute to the design of the proposal and identify alternatives to reduce adverse effects.

The general rule of thumb with consultation is to undertake it as early as possible. It is ultimately more time-efficient and can generate positive relationships and outcomes with those interested or affected. Another helpful recommendation is to undertake consultation frequently throughout the process, particularly if any changes arise. Consulting with tangata whenua is not mandatory under the RMA. However, it is best practice to undertake consultation with this group (Iwi) about the possible effects of a proposal.

Consultation is seen in a much broader context than acquiring written approval from adversely affected parties. However, written approval is required when someone is identified as being adversely affected by the proposal and this approval will assist in providing a more successful resource consent application.

2.8 Identifying effects

How are potential effects identified?

Councils may have checklists and although this may be useful, it is important not to see this as a box-ticking exercise.

Some things to think about when determining what or who is being affected include:

- Land, water, flora and fauna
- People (neighbours, communities, future people)
- Infrastructure
- Traffic and parking
- Cumulative effects.

How to determine the scale of the effect? Some common terms used to describe the level of effects are:

- Less than minor
- Minor
- Significant
- Major.

A good way to determine what category the effects fall into is to assess the level against what is permitted within the district or regional plan. Also, determine what is acceptable by assessing the aims of the plans' policies or objectives.

2.9 What is remedying, avoiding or mitigating effects?

The terms remedying, avoiding and mitigating are commonly used in the RMA, however, they are not well defined. The three terms are mechanisms that need to be considered when an application has the potential to have adverse effects. Each of the terms is a way in which the adverse effect can be addressed to ensure it is acceptable.

For example, a barn for housing cows may have an adverse noise effect due to the increased concentration of animals and heavy vehicle activity. The effect could be avoided if the structure was located where noise would not affect others. The effect might also be remedied by compensating. For example, supplying double-glazing to the nearest effected property, planting trees, or constructing bunds around the shed to reduce the noise levels.

The Ministry for the Environment (MfE) guide to preparing an AEE (1999) includes the following questions in Table 2.7 that are useful when approaching Council.

Table 2.7: Questions to Ask When Approaching Council

Questions to ask when approaching Council:

- Will consents be required from both district and regional councils? The council may refuse a consent if another consent is required. Also, note that a small number of councils are unitary and act as district and regional councils.
- How have other similar applications been processed recently and have they raised any particular issues? This may help identify shortfalls in your application.
- Will consultation with iwi/hapu be needed?
- Does the council know about any constraints or limitations on the site? This can include natural hazard risks, historical, archaeological or cultural significances.

3. Building Consents

3.1 The Building Act 2004

The Building Act (BA) covers the construction, alteration, demolition and maintenance of new and existing buildings throughout New Zealand. It sets standards and procedures for people involved in building work to ensure buildings are safe and built right first time. It covers how work can be done, who can do it and when it needs to be consented and inspected. Local district and city councils administer the BA as it relates to buildings. These councils are also known as a Building Consent Authority (BCA).

Under the BA, the Building Code (BC) defines the minimum standards buildings must meet. In contrast to the regional plans prepared under the RMA that do vary across the country, the BC provides a common set of minimum rules for the whole of New Zealand. However, many District Plans have definitions for buildings that differ from the BA, what constitutes a building under the Act may not be deemed a building under District Plan rules.

Excerpt from the Building Act 2004

8 Building: what it means and includes

(1) In this Act, unless the context otherwise requires, **building**– (a) means a temporary or permanent movable or immovable structure (including a structure intended for occupation by people, animals, machinery, or chattels)

3.2 What is a building consent?

A building consent is a formal approval granted by the local council under the BA that allows a person to carry out building work. Under the BA, building work required for cow housing is not viewed that differently to most similar commercial use buildings. Building work by definition includes work in connection with the site preparation, construction, alteration, demolition or removal of a building.

Building work, including agricultural structures, cannot be carried out unless a building consent has first been obtained. All building work must meet the minimum requirements of the BC and its performance requirements, even if no building consent is required by the BCA.

Shaping ideas, gathering information and talking to the right people early about a new building can save time and money for years to come.

Figure 3.1 and Table 3.1 set out 14 building consent process steps, some of which may not apply depending on the nature and scope of the project.

Figure 3.1: Resource and Building Consent Process

(Source: Ministry of Business, Innovation and Employment (MBIE) - A Beginner's Guide to Resource and Building Consent Processes)

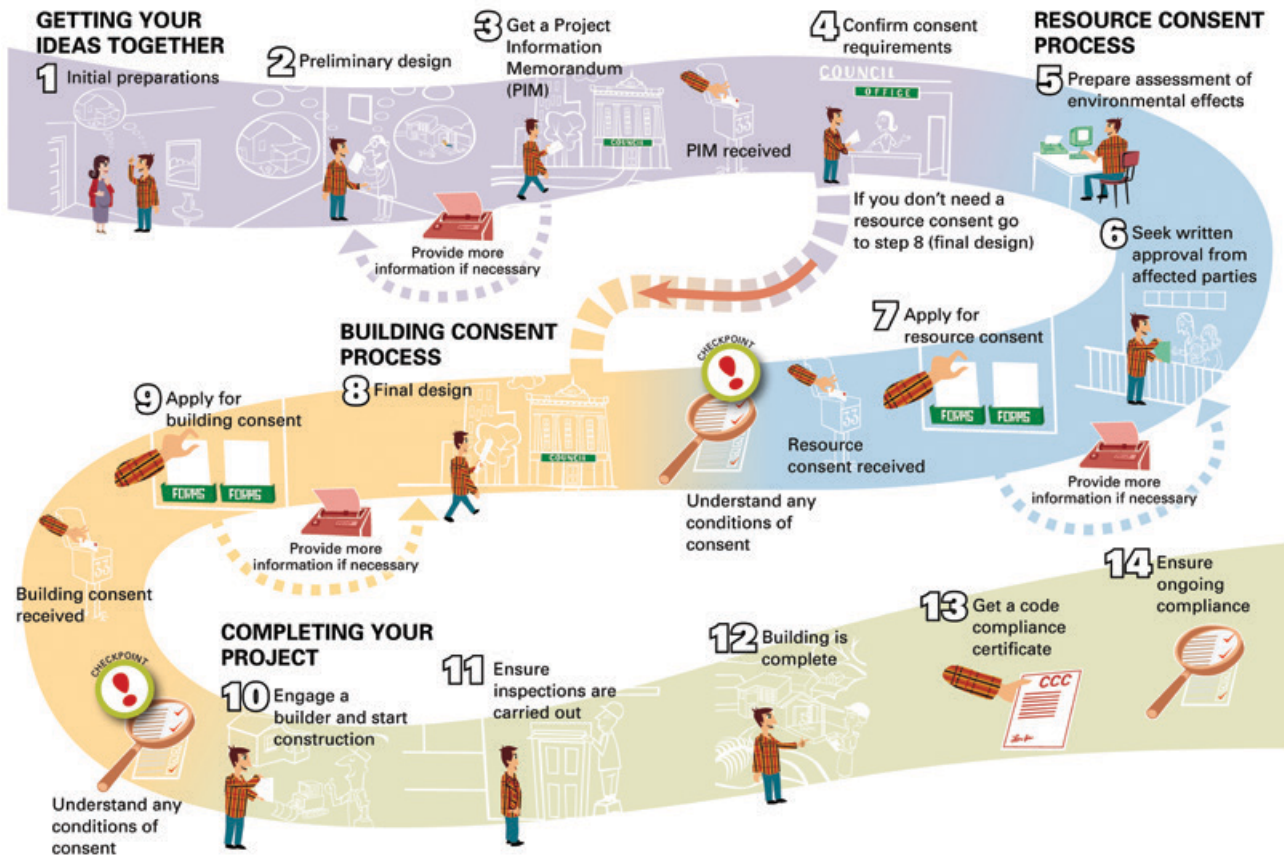

Table 3.1: Resource and Building Consent Process

| STEPS: | | | |
|--------|---|----|---|
| 1 | Initial preparations | 8 | Final design |
| 2 | Preliminary design | 9 | Apply for building consent |
| 3 | Get Project Information Memorandum (PIM) | 10 | Engage a builder and start construction |
| 4 | Confirm consent requirements | 11 | Ensure inspections are carried out |
| 5 | Prepare assessment of environment effects | 12 | Building is complete |
| 6 | Seek written approval from affected parties | 13 | Get a code compliance certificate |
| 7 | Apply for resource consent | 14 | Ensure ongoing compliance |

3.3 Building consent application

3.3.1 When to get a building consent

A building consent is required before doing any building work such as structural work, plumbing work, drainage work or site work for new buildings or alterations, or before shifting an existing building onto a new section. Building consent is essentially permission to carry out the building work in accordance with the plans and specifications for which the consent has been obtained.

Usually an engineer, architect, designer or contractor will submit the application as the owner's agent when the final plans are drawn. If the builder is undertaking both designing and building, the builder may apply on the owner's behalf.

Before applying for a building consent it is a good idea to get a Project Information Memorandum (PIM). A PIM is a report issued by a local council. It includes information that the Council considers relevant to the proposed building work. Information in the PIM may affect the project, which is why it needs to be sourced before applying for the building consent.

While applications for PIM's may not reduce the time council is allowed to process a BC, if the applicant is still awaiting a major input (for example, a structural engineering report), a PIM application may speed up the overall BC process. This approach may speed up time-critical projects, or at least prevent additional delays created by issues with planning that can be dealt with early while others are preparing the main BC application.

Note that the consent will lapse if the work is not started within 12 months of it being issued (unless otherwise agreed).

3.3.2 Building work not requiring consent

Building work in certain cases may be exempt from a building consent under the Building Act (Schedule 1). This schedule is divided into three parts depending on who can carry out the building work:

- Part 1 Exempted building work which lists work that anyone can carry out
- Part 2 Sanitary plumbing and drainlaying carried out by a person authorised under the Plumbers, Gasfitters and Drainlayers Act
- Part 3 Building work for which design is carried out or reviewed by a Chartered Professional Engineer and building has been carried out in accordance with that design.

These exemptions might only apply to very basic building related work around the farm.

Further information is available from MBIE's website.

3.3.3 How to apply for a building consent

Building consent application forms are available from any council office and, usually, on councils' websites.

When an application is ready to be lodged, an appointment will generally need to be made with the BCA. At the appointment, the receiving officer will check the application form, plans and specifications to check all the details have been covered and calculate the fee. The fee may be calculated on the cost of processing the application, or on a scale based on the value of the project. Fees vary from BCA to BCA and there may be additional charges.

An application will then be assessed for compliance with the Building Code. The BCA may use specialist consultants to assist in this assessment.

The BCA has to process an application within 20 working days, dependent upon all the information they require being supplied. Although applicants are within their rights to have it processed within this timeframe, many people experience much longer waiting times.

3.3.4 Building consent checklist

Any building work that requires building consent may include Restricted Building Work (RBW). Restricted Building Work can only be carried out or supervised by Licensed Building Practitioners (LBPs) and requires LBPs to provide documentation as part of the consenting process. The licensed designer (or Registered Architect or Chartered Professional Engineer) that draws the plans for RBW must provide a Memorandum (Certificate of Design Work) to be submitted with the building consent application.

The Department of Building and Housing's "Build It Right" website provides more information on restricted building work.

Each council may have different requirements for submissions of a building consent.

The checklists in Tables 3.2 and 3.3 and provide general guidance.

Table 3.2: Building Consent Application Checklist

Checklist of Information Required with a Building Consent Application

- Certificate of title, or a copy of the Sale and Purchase Agreement verifying ownership if the land has just been purchased and the title is not yet available
- Specifications providing a clear description of the materials and building elements that cannot be shown on the drawings. For example, durability issues, such as timber treatments, would be shown here.
- Engineer's reports and calculations
- The owner's intended inspections of the building work in progress. Any special arrangements that have created a need for inspection during construction, such as checking by an Engineer.
- Producer statements. Where the application is relying on a statement to certify compliance of the plans, specifications or completed works with the Building Code, a copy of that producer statement and the calculations it is based on must accompany the application.
- Solid Fuel Heaters (if applicable). These may need separate building consent application and must include the manufacturer's specifications and installation instructions and a floor plan of the building that clearly shows the proposed location of the heater unit and adjacent rooms, doors and windows.
- Water supply details. Where the property will not be connected to the council reticulated water supply, the location and size of tanks, the location of bores, test results and other information must be included.
- Alternative solutions should be fully documented
- List of specified systems (if applicable). Such as, emergency lighting or warning systems for fire.

Table 3.3: Drawing Information Checklist

Checklist of Information Required on Drawings

- Site plan which includes the road details, boundary dimensions, existing and proposed ground contours/levels, the site area, the outline of all buildings and distances to the boundaries, the points from which height control planes are taken, vehicle access-ways and car park(s)
- Foundation plan (with dimensions) which provides details of footings, reinforcing sizes and layout, foundation elements, sub-floor ventilation and engineering information
- Drainage plan showing building outlines, the location of all fittings, connections, inspection eyes and vents. On-site disposal systems must be accompanied by an engineer's design.
- Floor plans (with dimensions) providing details of the wall layout, windows, doors, fixtures and fittings, stove, plumbing, floor dimensions and smoke detection layout
- Bracing plans showing detail of wall layout with windows, doors, roof layout, bracing type, the location and fixing details of bracing panels and calculations for all floors
- Elevations showing accurate ground lines, levels, height recession planes, location of doors, windows (with opening windows clearly shown), floor levels in relation to finished ground levels, exterior claddings, roof covering, down-pipes, spouting, sub-floor ventilation and flues
- Sections and details showing details of the foundations, reinforcing, damp-proof membrane, stud heights, floor levels, wall structure (including proprietary wall-bracing element details), roof structure, roof covering, wall cladding, flashings, insulation, fire-rated systems, lintels and beams.

3.3.5 Amount of detail required

Each BCA may have different requirements for how many sets of plans need to be submitted. Some require that plans be drawn to a particular scale. Check with the BCA first to clarify.

The details provided in the documents listed in the checklist must be precise enough to show that what is being proposed will meet the performance requirements of the BC. For example, the documentation should clearly show how the building will keep water out by giving ground clearances, and information about claddings including flashings and guttering.

Each aspect of the BC requirements has to be covered in detail in the documents. If the documents are not complete enough, the BCA will request further information. When this happens the 20-day clock stops and does not restart until the amended documents are supplied. This delays the whole consent process.

3.3.6 Restricted building work

The design of primary structure, weather-tight elements or fire systems on residential buildings may be categorised as RBW. Design RBW can only be completed by (or completed under the supervision of) an LBP who is licensed in the design class. A Registered Architect or Chartered Professional Engineer is treated as LBP licensed in the design class. This allows them to design or supervise the design of RBW.

However, farm buildings (except those intended to house people) are exempt from the RBW requirements because they do not fit the criteria of residential building. It should be noted though that this RBW exemption should not be interpreted as meaning that farm structures do not need a building consent:

You can only supervise RBW if you are licensed to do so. As a designer, architect or engineer you might observe construction on-site and check that the work is being done in accordance with the building contract, but if you are not licensed to do that type of physical construction or alteration RBW, then you are not able to supervise and sign for that work.

3.3.7 Alterations to existing buildings

A building consent for an alteration to an existing building, including farm buildings, can only be granted where the BCA is satisfied that the building will:

- Comply as closely as is reasonably practicable with the building code provisions for means of escape from fire, and access and facilities for people with disabilities (if required)
- Continue to comply with the other provisions of the Building Code to at least the same extent as before the alteration.

The BCA may grant consent to allow alterations to take place without the building complying with the relevant provisions of the BC if it is satisfied that:

- If the building were to comply with the relevant provisions of the Building Code, the alteration would not take place
- The alterations will result in improvements to the means of escape from fire, or access and facilities for people with disabilities
- The improvements outweigh any detriment likely to arise because of the other non-compliance with the Code.

3.3.8 Determinations

If a building consent (or a Code Compliance Certificate) is declined by the BCA, an application can be made to MBIE for a legal ruling known as a Determination. It is a binding decision made by MBIE and provides a way of solving disputes or questions about the rules that apply to buildings.

3.4 Building consent amendments

3.4.1 Introduction

Changes to consented building work are often proposed during a building project. While the “approved building consent” obtained before work commences is the foundation document for most building work, the building consent process does allow this consent to be altered before or during construction through the formal “building consent amendment process”.

At the end of the building project, the approved building consent documentation needs to be an accurate reflection of what has actually been built.

MBIE has produced a very useful “Guide to Building Consent Amendments”. This guide sets out their expectations around notifying proposed variations to building consents, assessing those variations and making amendments to building consents. It encourages the early recognition, notification and actioning of consent variations and amendments.

An “amendment” means a change made to the original building consent, be it a simple alteration like an informal handwritten note on the consented plans by the consent applicant/builder/designer, or through a formal amendment as set out in the BA. All amendments must be approved and recorded by the BCA.

3.4.2 Minor design variations

A minor variation is a change that does not usually affect compliance with the Building Code, for example, positioning of non-structural walls or doors. Most often the minor variation does not affect the level of Building Code compliance; it simply achieves the same outcome but in a different way.

A BCA must still be notified about any proposed variation so it can confirm the change is minor, advise how they will deal with it and record the minor variation in writing. All minor variations that are approved must be recorded in writing. For example, a hand-written note on the consented plans or inspection record note.

3.4.3 Major design variations

Generally, work that is outside the scope of the original consent (for example, additional footprint or increases in floor area, construction method, or significant changes to the layout), is considered a major variation. A formal amendment is required for this new work to be undertaken.

Variations that are major often result when a number of Building Code clauses affect the variation. Where compliance with the Building Code will be significantly affected, as in a major variation, a formal amendment will be triggered. If approved, any amended application becomes part of the approved building consent documents file for that building project.

Figure 3.2 illustrates the actions for either a minor design variation or a major design variation.

Figure 3.2: Minor and major design variations

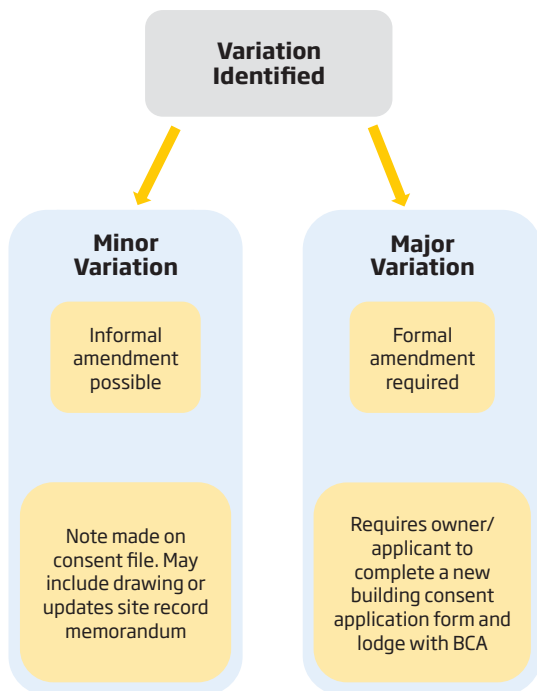

3.5 Building consent compliance inspections

3.5.1 Purpose of inspections

The BCA will inspect the building work at specific stages identified in the building consent and again at completion. There will usually be a form attached to the building consent identifying these stages.

It is the owner's responsibility to let the BCA know when these stages have been reached. The building contractor or the people managing the project, unless the project is being managed directly by the owner, will usually carry this out on the owner's behalf. The BCA needs to be given notice to inspect the following before they are either covered up or closed in:

- Drainage, plumbing, gas fitting or electrical work
- Excavation for a foundation
- Reinforcing steel for a foundation
- Timber required to have a specified moisture content
- Any other building work that is required as a condition of the building consent.

These inspections are undertaken to ensure the work complies with the consent documentation.



Construction underway

3.5.2 Final inspection and code compliance certificates

The owner must advise the BCA when work is completed and apply for a code compliance certificate (CCC). In reality, this is likely to be delegated to the builder or project manager. The BCA will then make a final inspection and issue a CCC if satisfied on reasonable grounds that the completed work complies with the consent documentation.

A licensed practitioner is required to supervise or undertake certain building work. However, owners who undertake building work themselves can sometimes be exempt from this requirement as long as they meet certain conditions. More information on this exemption can be found on the Department of Building and Housing website.

If the inspecting Building Official finds work that does not comply with the building consent during the construction or at the final inspection for the issue of the CCC he may issue a "Notice to Fix". The owner is legally required to make sure the work on the notice is corrected and advise the council when work is completed. The owner may have to reread their contract with the builder to determine who is responsible for the work that needs fixing. The Council will inspect and consider whether a CCC can be issued once they have been advised that the problems have been fixed.

There is a considerable emphasis on getting a CCC under the 2004 Building Act. There are several significant advantages in doing so. For example, when the property is sold, not having a CCC for a building on it could be a major obstacle because sale and purchase contracts are often conditional on a CCC having been granted.

Key points - for building consent applications

- As far as possible, finalise the details of what is required to be built before applying for a building consent. If changes are likely to be made after the building consent has been approved, allow for additional costs and time delays.
- Factor amendments into contingency planning and budgeting, particularly if alteration or renovation of an existing building is being considered. It is often difficult at the planning and initial design stage to predict all the factors about an existing building that will affect the new building work.
- Consider applying for a Project Information Memorandum (PIM) well before applying for building consent. This can give information about the site, which might influence planning and design, and provide early notification of other required approvals. For example, resource consents, Historic Places Trust approvals and so on.
- Discuss the project with the builder/designer/owner before submitting the application for building consent. For instance, the builder may prefer to work with factory-manufactured trusses rather than constructing them as the designer has detailed in the consent documents.
- The building consent application and any subsequent amendments that may be necessary, must contain sufficient detail to give the building consent authority “reasonable grounds” on which to make its decision. The designer (and/or builder) must demonstrate compliance.
- If the BCA asks for an amendment to the building consent using its application form, submit the application as soon as possible to avoid delaying the building work. Work on the affected area often cannot start, or continue, until the BCA has made its decision on the amendment application.
- Even if an amendment application does not need to be submitted, all the as-built information the BCA asks for still needs to be supplied. This ensures the consent file held by the BCA remains up to date and enables the code compliance certificate to be fully considered and issued quickly when building is complete.

Key points - for builders, designers and project managers

- Build from the approved building consent plans and specifications. Store them carefully on site and refer to them frequently throughout the project.
- When preparing an application for a building consent amendment, present information on the plans and specifications that relates to compliance with the Building Code in a way that is clear and easy for the BCA to follow. Avoid, or separate out, details that do not relate to compliance with the Building Code. Make the changes clear and obvious for consent processing staff. Designers could use a Design Summary Form for this purpose, which is good practice.
- Advise the owner if considering variations to the building work in any way that differs from the approved plans. Ultimately, the owner is responsible for the building work and for obtaining a CCC.
- Do not carry out building work that is a variation from the approved consent until the proposed variation has been discussed and approved (whether formally or informally) by the BCA
- Give as much notice of amendments as possible to avoid or limit delays
- Involve the designer in the process of considering an amendment to ensure the proposed variation does not affect other parts of the building work
- The building consent application and any subsequent amendments that may be necessary must contain sufficient detail to give the BCA “reasonable grounds” on which to make its decision. The designer (and/or builder) must demonstrate compliance.
- Explain why the proposed variation is necessary and be prepared to offer a view on how it complies with the Building Code (the designer may have primary responsibility for this). It will help support any request for an amendment.

References

RESOURCE CONSENTS

Legislation

Resource Management Act 1991

www.legislation.govt.nz/act/public/1991/0069/latest/DLM230265.html

Ministry for the Environment

(Some information from these documents was drawn on to develop this section.)

An Everyday Guide to the RMA: Consultation for resource consent applicants (December 2009)

www.mfe.govt.nz/publications/rma/everyday-guide-rma-consultation-resource-consent-applicants

An Everyday Guide to the RMA: Applying for a Resource Consent (December 2009)

www.mfe.govt.nz/publications/rma/everyday-guide-rma-applying-resource-consent

A Guide to Preparing a Basic Assessment of Environmental Effects (August 2006)

www.mfe.govt.nz/publications/rma/ae-guide-aug06/

About the National Policy Statement for Freshwater Management

www.mfe.govt.nz/fresh-water/national-policy-statement/about-nps

DairyNZ

Odour Management

www.dairynz.co.nz/environment/effluent/effluent-storage-ponds/odour-management/

Dealing with the Odour Issue

www.dairynz.co.nz/environment/effluent/effluent-storage-ponds/odour-management/dealing-with-the-odour-issue/

BUILDING CONSENTS

Legislation

Building Act 2004

www.legislation.govt.nz/act/public/2004/0072/latest/DLM306036.html

Ministry of Business, Innovation and Employment (MBIE)

(Some information from these documents was drawn on to develop this section.)

Building and Housing Information - Publications

www.dbh.govt.nz/publications-a-z

Guide to Building Consent Amendments (September 2008)

www.dbh.govt.nz/UserFiles/File/Publications/Building/Guidance-information/pdf/guide-to-amendmnts-sept-08.pdf

A Beginner's Guide to Resource and Building Consent Process

www.dbh.govt.nz/UserFiles/File/Publications/Building/Building-Act/resource-and-building-consent-processes.pdf

Minor Variations to Building Consents: Guidance on definition, assessment and granting

www.dbh.govt.nz/UserFiles/File/Publications/Building/Building-Act/guidance-on-minor-variations.pdf

Building Work That Does Not Require a Building Consent (Third Edition 2014)

www.dbh.govt.nz/UserFiles/File/Publications/Building/Guidance-information/pdf/building-work-consent-not-required-guidance-3rd-edition.pdf

Restricted building work

www.dbh.govt.nz/builditright

Owner Builder Exemption

www.dbh.govt.nz/builditright-homeowners-owner-exemptions

DISCLAIMER

DairyNZ Limited (“DairyNZ”, “we”, “our”) and the Institution of Professional Engineers New Zealand (IPENZ) endeavour to ensure the information in this Practice Note is accurate and current. However we do not accept liability for any error or omission, nor can we be held responsible for its accuracy, currency, or fitness for purpose as best practice is subject to change without notice.

The information in this Practice Note is intended to provide the best possible advice DairyNZ and IPENZ have access to. It is important to note the information is provided as general guidance only and is not intended as a substitute for specific advice. Practices, systems, and advice may vary depending on the individual circumstances. The information may also be subject to change at any time without notice. DairyNZ and IPENZ take no responsibility whatsoever for the currency and/or accuracy of this information, its completeness, or fitness for purpose.

COPYRIGHT

Copyright in this publication (including text, graphics, logos, and icons) is owned or licensed to DairyNZ.

Other than for the purposes of, and subject to the conditions prescribed under, the Copyright Act 1994 and similar legislation which applies in your location, and except as expressly authorised by these terms and conditions, you may not in any form or by any means adapt, reproduce, store, distribute, print, display, perform, publish, or create derivative works from any part of this publication or commercialise any information, products, or services obtained from any part of this publication without our written permission.



To facilitate the delivery of this Practice Note, DairyNZ have engaged Opus International Consultants Ltd as the lead consultant.

Lead Author/Editor: Rex Corlett FIPENZ, CPEng
Principal Engineer - Opus Rural
Christchurch, New Zealand

© DairyNZ 2015



Version History

Version 1 - July 2015

The Institution of Professional Engineers New Zealand Inc.

Pūtahi Kaiwetepanga Ngaio o Aotearoa

PO Box 12 241
Wellington 6144
New Zealand

P +64 4 473 9444
E ipenz@ipenz.org.nz
   EngineersNZ

www.ipenz.org.nz